

Hernando Barragán | Interaction Design Institute Ivrea | June 2004

h.barragan@interaction-ivrea.it

# Wiring: Prototyping Physical Interaction Design

## Thesis Committee

**Massimo Banzi** . Associate Professor

*Primary advisor*

**Casey Reas** . Visiting Assistant Professor

UCLA Design | Media Arts,

*Secondary advisor*

**Gillian Crampton Smith** . Director

**Andrew Davidson** . Chair of the Academic Programme

# Wiring: Prototyping Physical Interaction Design

Hernando Barragán

## o. Abstract

### o.1 Problem

Design education and practice increasingly rely on digital technology. For designers to successfully enter this domain they need to understand the inherent qualities in the media they work with, such as electronics and software. Current prototyping tools for electronics and programming are mostly targeted to engineering, robotics and technical audiences. They are hard to learn, and the programming languages are far from useful in contexts outside a specific technology. Designers need a teaching language and electronics prototyping system that facilitates and encourages the process of learning, that reduces the struggle with electronics design and programming, and that are powerful and flexible enough for the needs of Interaction Design.

### o.2 What is it

Wiring is both a programming environment and an electronics prototyping input/output board for exploring the electronic arts and tangible media. It can also be used to teach and learn computer programming and prototyping with electronics. It illustrates the concept of programming with electronics and the physical realm of hardware control which are necessary to explore physical interaction design and tangible media aspects in the design discipline. The Wiring software and the hardware designs of the Wiring electronic input/output board will be freely available for download on the Web. Users will have access to the Wiring electronic in-

put/output board as well. The site contains a reference, and a number of short prototypical examples that explore the media and illustrate the code and the electronics diagrams allowing users to learn by experimenting with them.

Wiring builds on Processing, the open source programming language developed at the Massachusetts Institute of Technology Media Lab and Interaction Design Institute Ivrea by Ben Fry and Casey Reas. People who learn how to program using Processing can instantly move to program in Wiring and then to other languages or scripting environments like Java, C, C++, JavaScript, Flash or Director.

While working on their design concepts, users will be able to sketch, test their ideas and prototype them, by writing small programs and downloading them to the input/output board. The Wiring input/output board is a general purpose electronic system that includes a microcontroller where the users' programs will run. It provides digital and analog inputs and outputs and functionality that will allow users to interface all kind of sensors and actuators and program the behaviors needed in their projects.

This project aims to support education not only in the design and art schools but also in different types of learning environments and different types of practices. It will enable users to quickly prototype their ideas and concepts in the physical world, allowing users to concentrate on the quality of their designs, the interaction, ideas, or concepts being illustrated, rather than concentrate on showing that the technology works. It will contribute to sharing ideas and knowledge with the wider community of interaction design and in general to others outside this field. Because it builds on the Processing language, it will take advantage of the existing online community of users around the world and their collective experience. It also builds on my previous professional experience as engineer artist and designer.

# Wiring: Prototyping Physical Interaction Design

Hernando Barragán

## Acknowledgments

This thesis is dedicated to my huge family, (too many to name you all guys), especially to my grandparents Rafael y Maria, and my grandparents Antonio y Edelmira who both passed away while I was here.

I am extremely grateful to Casey Reas for his support and encouragement; It's been an honor to have him as mentor and friend and a constant source of inspiration and perspective, thank you. I thank Massimo Banzi for his support. I also thank all the members of the community at Interaction Design Institute Ivrea past and present for their valuable insights: Gillian Crampton Smith, Andy Davidson, Bill Verplank, Jan-Christoph Zoels, Stefano Mirti, Reed Kram, Clemens Weisshaar, Edoardo Brambilla, Simona Maschi, Britta Boland, Nathan Shedroff, Molly Write Steenson, Camille Norment, Durrell Bishop, Anthony Dunne, Fiona Raby, Dag Svanæs, Peppino Ortoleva. I thank all the IDII community who directly or indirectly contributed to my education and life in the last two years. Thanks to Linda Norlen and Christian Palino for their support in the elaboration of this document.

Thanks to Tiberio Hernandez for being my mentor, for his vision and always letting me do whatever it comes to my mind, Rafael Gomez for sharing his passion for programming and hardware, and Rodrigo Cardoso for his wisdom.

Thanks to Ben Fry, the Processing development team, Mauricio Giraldo, Brian Dean, Peter Gasparik, Alberto Alberton, Pascal Stang, Dan O'Sullivan, Tom Igoe, Michal Rinott, Karmen Frani-  
novic, Myriel Milicevic, Maya Lotan and the Internet guys for their support. A big thanks goes to my class, who have been an amazing experience in my life. I also want to thank the first and the next generation of students at IDII; it was great to share with you guys.

Very special thanks go to all my friends for being always there.

# Contents

<b>3</b>	<b>0. Abstract</b>
3	0.1 Problem
3	0.2 What is it
<b>15</b>	<b>1. Introduction</b>
15	1.1. Physical Computing
16	1.2. Microcontrollers
<b>22</b>	<b>2. Background</b>
22	2.1. Learning computer programming
24	2.2. Learning and prototyping with electronics
29	2.3. Contributions from the industry
33	2.4. Contributions from Physical Computing classrooms
<b>35</b>	<b>3. Concept development</b>
36	3.1. First Experiment

41	3.2. Second Experiment
47	3.3. Third Experiment
<b>49</b>	<b>4. Design and Implementation</b>
49	4.1. Wiring Software
50	4.2. Wiring Hardware
56	4.3. Wiring Web Site
57	4.4. First users
61	4.5. Reactive tables (Powered by Wiring)
62	4.6. Prototyping aids
64	4.7 Class support material
<b>67</b>	<b>5. Conclusions and Future Direction</b>
<b>69</b>	<b>6. References</b>
74	Apendix A. Wiring I/O Board Circuit Schematics
75	Apendix B. Wiring I/O Board Layout

## 1. Introduction

This chapter gives an overview of related work; prototyping with electronics in art and design schools in the field known as physical computing. It will introduce the subject of physical computing in the educational context, then present different projects that address in some way the components involved in this activity, such as learning computer programming and basic electronics; and discuss some interesting cases relevant for this investigation.

### 1.1. Physical Computing

What is physical or tangible computing? Many approaches to this term, and in general to human computer interaction or tangible user interfaces, have been and are under development right now. Still in its early stages physical computing emerges as a space or foundation for exploring the concepts, future and role of computing in our physical environment. Several people and institutions have been involved in this movement or so-called phenomenon, sharing a common basis but differing in their goals, approaches and applications.

Different curriculums have been proposed at the core of different design and art schools to establish physical computing as something that can be taught and learned. Such programs empower art and design students with the abilities and skills necessary to respond to the challenge of increasingly pervasive technology in our society. Physical computing is playing an important role in the development of contemporary art and design as it relates to the contexts of electronic media.



The Interactive Telecommunications Program (ITP) at New York University (NYU), the Computer Related Design program at the Royal College of Art (RCA) in London, Parsons School of Design, Human Computer Interaction at Stanford University, School of Visual Arts (SVA) and Washington University, among others, are very interesting sources on this subject. Each of the programs in these schools is quite different from each other, as is the kind of works produced and the audiences. As a common basis, the courses introduce students to the basics of electronics, circuit design, prototyping, sensing technologies, simple microcontrollers, computer-controlled artifacts, actuators, networked projects, video tracking and analysis technologies, technical aspects in installations, remote presence and hacking existing electronic devices and robotics, among others.

Teaching and learning physical computing is not a small task. Appropriate teaching curriculums have to be developed to integrate activities like computer programming, basic electronics, and support software and hardware tools with the educational context. Since most of the students in these courses come from art, design and humanities-related disciplines, the classes should be targeted to people with no previous technical or engineering skills.

## 1.2. Microcontrollers

Microcontrollers are a kind of small computer device that addresses some of the difficulties involved in prototyping with electronics by introducing the concept of programming into it. The same unit can behave in different ways, just by doing or modifying a software program to adapt it to a specific need or purpose. Computer programming is completely independent from electronics or a programming language in particular. The programming languages available to program microcontrollers range from native versions of assemblers, C, and BASIC, but there are others that can be programmed in most popular programming languages like Java or Logo. All of these programming languages have their weaknesses and strengths when it comes to ease of use, functionality, development environments and interfaces for development. In most cases they are attached to the very specifics of a technology, making it difficult to learn the basics of programming and electronics at the same time. For this reason, it is a daunting task for a designer or artist to know where to turn when building a prototype or developing an idea.



1  
40-Pins PIC Microcontroller  
Microchip Inc.

Software tools are built upon layers of abstraction from assemblers to programming languages or graphical user interfaces, which were the result of decisions made by many programmers and electronic engineers. As a result it is unlikely that appropriate tools for designers might come out from the technology industry, but perhaps allowing designers to create or participate or shape their own design tools.

*From the point of view of a computer user with little or no skill in programming, who wants to create interactive software [and products] the current technological development has created the following situation:*

*The simplifications and abstractions made by the tool designers make it practically impossible to experiment with and implement many interactive solutions that are technically possible.*

*The user's image of the design-space concerning interaction is fragmented and incomplete. It is shaped by the tools they have been using and by the solutions they have seen. Consequently, many solutions that are technically possible are "unimaginable" to most interaction designers. (Svanæs 3)*

Nowadays there is a wide range of popular, powerful, and relatively inexpensive microcontrollers available on the market for commercial, educational, hobbyist and entertainment markets. However, the knowledge of hardware and programming required to put them into production is quite vast and difficult to grasp for audiences other than the targeted audiences of engineering, intermediate and advanced users.

Programming language, functionality, cost, ease of use, availability of free software and examples, and documentation are all factors that must be taken into consideration when choosing the right microcontroller.

The microcontroller's functionality varies from basic logic control up to fully functioning computers with wireless Internet or network access, RF communication, Bluetooth, GPS capabilities, and more complex systems. Many companies like Motorola, Microchip, Parallax, Texas Instruments, Rabbit Semiconductors, ATMEL, UBICOM, Dallas Semiconductors etc. have a vast selection of programmable devices, and in some cases a single company offers hundreds of families of microcontrollers.

There are audiences from diverse disciplines that are potentially interested in design, prototyping and programming in the context of electronic media, and would like a way that facilitates and encourages their process and allows them to test and come up with new ideas and possibilities. However, these audiences may not have the needed programming, electronics and math skills. A system oriented towards these audiences is needed, to allow programming and prototyping with electronics. Such a system needs to facilitate learning concepts that can be mapped and useful in different contexts.

Explained in a very simple way, a microcontroller is an electronic device with a set of Input and Output pins. Physically these pins may look like real pins, or can be just connectors of some kind that other devices can be plugged to, depending on the microcontroller; there are some that are single units and others that are a complete electronic board with access to the pins through connectors.

Depending on the microcontroller's functionality, the pins can be inputs or outputs, so they can be used to receive and send signals. The signals can be discrete, in the case of digital binary signals where the possible values are logical 0 (LOW) or logical 1 (HIGH). These values (HIGH or LOW) are reflected in changes in voltage, let's say LOW is 0 volts, and HIGH are 5 volts.

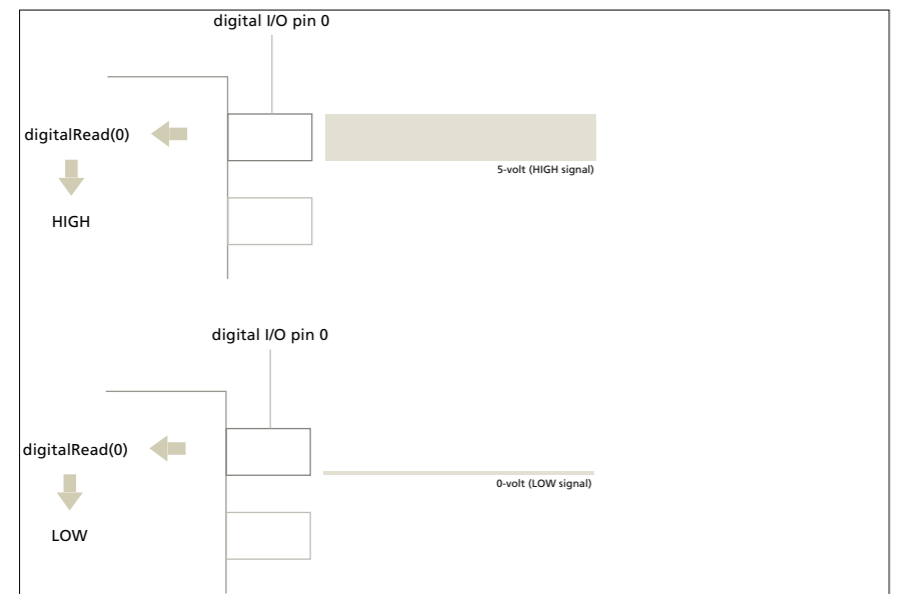

Reading the value of a digital input pin.

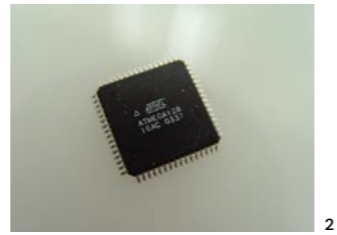

AVR atmega128 microcontroler  
Atmel Corp.

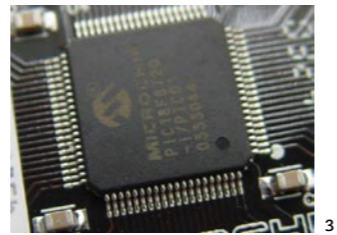

80-Pin PIC Microcontroller  
Microchip Inc.

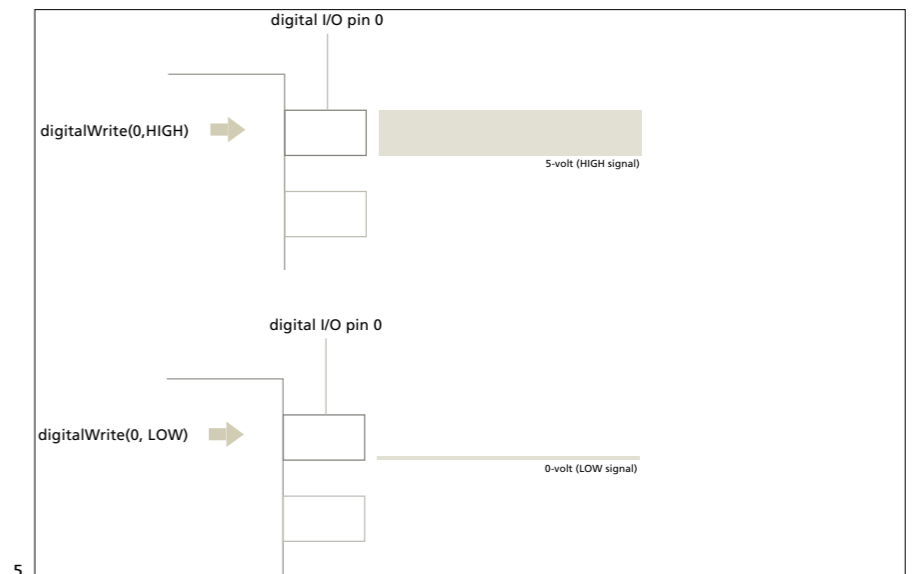

Setting the value of a digital output pin

Signals can also be of analog nature. Many physical phenomena manifest in this way, like measuring light intensity, temperature, sound or position, where there is a range of intermediate values that can be measured. In this case a pin in a microcontroller can be used as what is called an analog input or an analog-to-digital converter (ADC). In an ADC a range of analog values is converted to a range of numbers, depending on the precision of the ADC, for instance an 8-bit precision ADC can differentiate between 256 possible values because that's the maximum decimal number that can be represented with 8 bits; others use 10-bit precision for conversion, which can generate values between 0 and 1024. When an analog pin reads 0 volts it returns a 0 and when it reads 5 volts, returns the value 1024, with possibility of all the values in between the range: 2.5 volts returns 512 and so on.

Microcontrollers also have analog outputs that work in a way very similar to the analog inputs, but technically different. Usually the analog output is done through a process called Pulse Width Modulation (PWM) that consists of generating a pulse train in a normal digital output. This is equivalent to turning the pin ON and OFF very quickly, as it is done in dimmers for lamps or motor speed controllers so the lamp or motor is not ON all the time but only part of it, reducing its actual performance time. Real analog outputs can also be found; they are known as a Digital-to-Analog Converter (DAC), again depending on the precision with which they can convert a digital number into a voltage value on a physical pin.

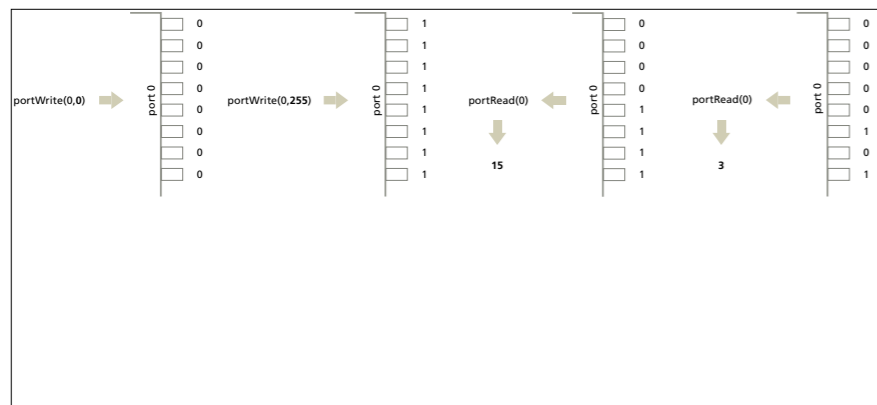

Port reading and writing

6

Some microcontrollers provide access to individual pins or to groups of pins at the same time. Groups of pins are known as Ports. For example, an 8-bit port is a set of 8 pins. The microcontroller provides functionality to write a value to a port, and will set the values of the individual pins accordingly. This is useful to control special kinds of devices or write data in parallel.

Microcontrollers also have timing abilities, usually a few timers that can be used in different ways to measure time lapses, trigger events, synchronize functions, etc.

Microcontrollers have communication capabilities, usually with serial ports, the same kind of serial ports that are available in most computers. In this way they can connect and communicate with other devices using the well-known serial protocols. In many cases the serial ports are used for both programming the microcontroller and for communication purposes.

In general, programming a microcontroller is a process with two components. One happens in a PC or host computer, and the other in the microcontroller itself. On the PC there is what is called a programming development environment, which generally includes an editor for the user to type its programs, and include the functionality to compile and generate the necessary files that are understandable by the microcontroller. When the user code is compiled, it is converted to machine language, a language that is understandable by the microcontroller and written to what is known as object binary file. This binary file can be downloaded to the microcontroller and then executed by it. To download the file to the microcontroller, a special setup is needed, usually done through a serial port,

so a physical connection between the microcontroller and the host computer is done using the serial port. At this point the microcontroller can be disconnected from the host computer, since the program is downloaded to the microcontroller; it will stay in the microcontroller memory and will be executed constantly. Every time the microcontroller is turned on, it will execute this program.

Microcontrollers, at least the kind of microcontrollers mentioned in this investigation can be re-programmed as needed.

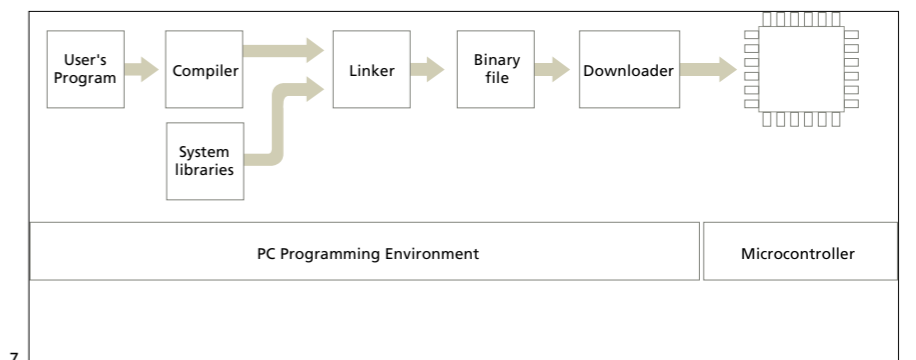

Microcontroller's programming process

7

## 2. Background

Academic and private companies have created several software and hardware systems for education, to provide a solution for teaching and learning computer programming and prototyping with electronics. I will present a brief description of some of these projects.

### 2.1. Learning computer programming

Logo was developed by a team from MIT, and was originally designed to introduce children to programming concepts, to develop better thinking skills that could be transferred to other contexts. Logo was supposed to be a language for the teaching of mathematical ideas to children through computer programming. It was intended to be easy to learn, easy to use, easy to read, but also powerful and able to cope with complex problems. It was then discovered that Logo extended far beyond mathematical areas. The man who became the spokesperson for this language was Seymour Papert.

Focusing on the aesthetic qualities of computation and computational media design, Professor John Maeda and students in the Aesthetics + Computation Group at the MIT Media Laboratory created Design by Numbers (DBN), which is both a programming environment and a language. The environment provides a unified space for writing and running programs and the language introduces the basic ideas of computer programming within the context of drawing. Visual elements such as dot, line, and field are combined with the computational ideas of variables and conditional statements to generate images. (Maeda, 1999)



8  
Microworlds Logo  
Microworlds, 2004

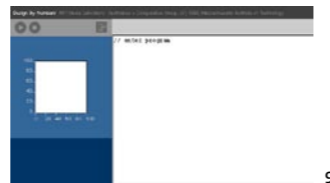

9  
DBN  
MIT Media Lab, 1999

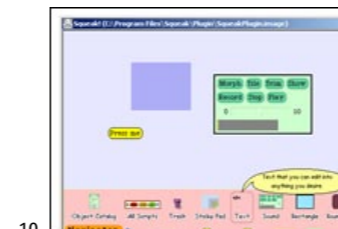

10  
Squeak.

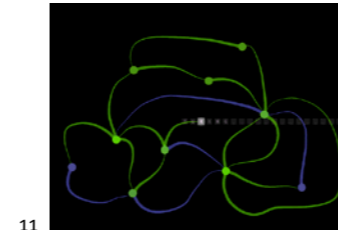

11  
Turing, Interactive visual representation of Alan Turing's machine.  
Jared Schiffrman, 2000



12  
Processing  
Ben Fry, Casey Reas 2004

DBN is not a general purpose programming language like C or Java, but was designed to familiarize people with the basic concepts of computational media.

Sponsored by private institutions, Alan Kay and some colleagues developed Squeak. It is a program designed for children to express ideas about math and science, and to enhance children's learning in these areas. Users can build computational systems with it.

Boxer is under development at UC Berkeley by Andrea A. diSessa and Edward H. Lay and some parts are copyrighted by MIT. It is a computational medium based on a literacy model, including text and hypertext processing, dynamic and interactive graphics, video, personal data management, (including e-mail and networking) and programming.

The Visual Machine Model created in the MIT Media Laboratory at the Aesthetics and Computation Group by Jared Schiffrman, emphasizes the need for clear visual representations of both machines and materials, and the importance of continuity. It presents a new paradigm for the design of visual programming languages, with the goal of making computation visible and, in turn, more accessible. Five dynamic visual programming languages were designed and implemented according to the specification of the Visual Machine Model. (Shiffrman, 1999)

Processing, created by Ben Fry and Casey Reas of the Aesthetics + Computation Group at the MIT Media Laboratory and Interaction Design Institute Ivrea is a learning program and environment for creating systems in a subset of the JAVA programming language, with real time three-dimensional graphics, color, input/output and other features that DBN lacked.

The spirit of Processing is to act as an electronic sketchbook where people can learn the fundamentals of computer programming within the context of the electronic arts (Reas, 2003).

Both Design By Numbers, and Processing are systems that introduce the basic ideas of computer programming within the context of visual design. Form elements are drawn using computational concepts like iteration, repetition, variables, and conditional statements, as well as structural elements like functions and classes. They are powerful educational tools designed for adults, allowing users to create programs that manifest mainly on the computer screen. With Processing, users can create beautiful graphics that are interactive and dynamic.

A number of workshops have been taught using Processing, refining methodologies and teaching curriculums, making the concepts of visuals and interaction to emerge in the process of learning computer programming. WorkWorkshops also facilitated the project's communication, impact and further development.

## 2.2. Learning and prototyping with electronics

In the projects described above, the users learn the basics of computer programming by creating applications that manifest on the screen, but can not extend these concepts into the physical world, which is necessary to explore physical interaction design and tangible media aspect. Most of the systems used in teaching and learning physical computing were never intended for education. They originated from the electronics and radio hobbyists, the robot design field and robotics applications. These introduced the concept of "Kits", semi-complete sets that include basic electronic components as a common basis for beginners to start their explorations.

To build and design robots, Professor Fred G. Martin at the MIT Media Laboratory, designed several systems.

The Mini Board designed at MIT Media Laboratory by the Professor Martin and his colleagues was a single board computer optimized for controlling small DC motors and receiving data from various sensors, initially intended for controlling small mobile robots. It communicates with a desktop computer over a serial port, making it suitable for desktop computer-based control as well. It was designed in 1990, and since then several copies of the board were printed out and distributed.

In 1989 Professor Martin designed the 6.270 Board which was very complex board compared to the Mini Board. The project became a class called 6.270: The MIT LEGO Robot Design Competition, intended for students to create fully autonomous robots. This class is today a student-run activity where past students become future organizers.

Students received a Kit containing LEGO parts, electronics, sensors, batteries, motors and wire; they had a month to design, build and debug an autonomous contest robot.



13  
The Miniboard  
Fred Martin, 1990

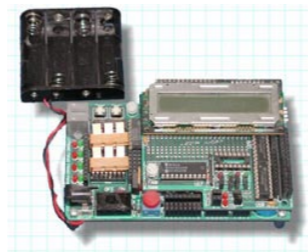

14  
6.270 Board  
Fred Martin, 1989



15  
6.270 Class  
MIT



16  
The Handyboard  
Fred Martin, 1999

Professor Martin also designed the Handyboard, which was more powerful than the Mini Board but less complex than the 6.270 board, making it a more useful overall package. It was designed from readily available components, fitting in a commercial plastic enclosure and running from a single rechargeable battery, it also uses fewer components. The Handy Board was the first microcontroller I ever used for my own art projects. Within the expansion board it is a powerful computer, and it is based on the Motorola 68HC11 microcontroller.

In order to program it, there are free assembler compilers available as well as commercial C compilers.

This kit is compatible with the Interactive C, which is a programming environment created for the MIT LEGO Robot Design project. It is a multitasking C language compiler originally created for students.

The Handyboard is a very interesting case, because it was designed with the robot design in mind. It was intended for engineering students and an audience with a programming and technical background, and was one of the milestones in robotics and hobbyists activities. There was also a step in the direction of providing both a hardware and software integrated solution for its audience. Another important aspect is that it was distributed to a wider audience than that of research labs. It was built, marketed and distributed by different parties, with all the necessary documentation to build it freely available and released to public. The companion software was also distributed freely and downloadable from the web, even if the user didn't purchase the board from the distributor. The software provided support for Windows and Macintosh systems.

At the hardware level it provided direct connections to motors, servos, sensors; it was designed to be a plug-in platform. The downside was in the cost since it was a relatively expensive device.

The Interactive C programming language is a subset of the C programming language, with a simplified syntax and multitasking capabilities. The system provided libraries that made certain common activities like the use of motors and servos very simple, but complex elements remained in the language, making it difficult to be used as the first programming language for non-engineer user to learn. Because it also inherited many low level commands and technical elements from the C language, it was very difficult for non-technical audiences to grasp, but very interesting for those who already knew how to program or

already knew C, and didn't want to go into the intricacies of low-level languages like assembler.

*The C programming language is the most widely used programming language since it was devised in the 70s. After some years of development it was standardized by the ANSI X3J11 committee. In the beginning it was associated with the UNIX operating system, but later it expanded to all available systems becoming the most spread programming language ever. Its abstractions lie in a sufficiently high level that, with little effort, portability between machines can be achieved. On the other hand the relationship between arrays and pointers, the way declaration syntax mimics expression syntax, memory management and in general some syntax particularities often serve as a stumbling block for beginners. Its success lies in its portability, it remains as a simple and small language. It was created as a tool to make useful programs that do useful things, covering the needs of many programmers without trying to supply too much things. It displaced languages like assembler while maintaining an abstraction level of machines and fluent enough to describe algorithms and interactions in a wide range of environments. (D. Ritchie 1993)*

People at the Lifelong Kindergarten Group (LLK) at the MIT Media Laboratory are working on the development of educational tools for learning concepts about hardware and computation. Over the past decade, LLK worked on the development of Programmable Bricks.

The Programmable Brick is a tiny portable computer embedded into a LEGO brick for kids to build into their LEGO systems. Kids can create robots or stand-alone projects, not only structures and mechanisms, but also behaviors. The aim is to teach kids concepts about engineering design and technology by bringing computation to their physical environment. Programmable Bricks have expanded into two areas. On the commercial side, they evolved into something called the RCX Brick that became the foundation for LEGO Mindstorms, a commercially available set of toys that lets users build robots and computational projects using LEGO blocks.

The programmable evolve into Crickets, which are tiny computers powered by batteries that can communicate with each other by infrared light. Each can operate two motors and receive information from two sensors. They are programmed in a dialect of the LOGO language. An evolution of crickets is available commercially as the Handy Cricket made by Fred Martin and his colleagues. A set of



MIT Programmable Brick  
LLK MIT Media Lab

17



LEGO RCX Programmable Brick  
LEGO Mindstorms, 2002

18



LEGO Rotational sensor  
LEGO Mindstorms, 2000

19

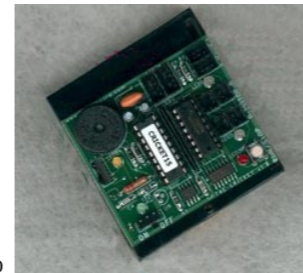

The Handycricket  
Fred Martin, 2003

20

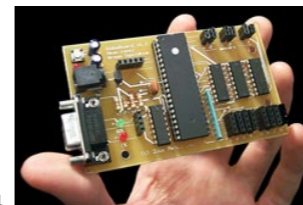

The GoGo Board  
Arnan (Roger) Sipitakiat, 2002

21



Nylon  
MIT Media Lab, 2002

22

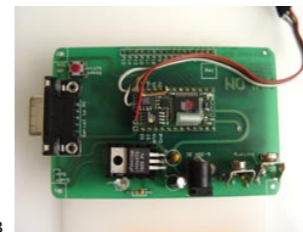

Nylon (inside)

23

sensors and actuators are marketed with this system, that interfaces with the regular LEGO brick and the Programmable bricks, but which make it difficult or impossible to connect electronic devices that are not part of the set.

LogoBlocks is the graphic programming environment that lets the user create iconic programs to control a Programmable Brick. To create programs, you just drag blocks from a palette and snap them together on a canvas.

The GoGo Board is a simple I/O interface developed at the Future of Learning Group at the MIT Media Lab by Arnan (Roger) Sipitakiat. It is used in projects that need a simple interface between the computer and sensors, very useful for projects that need to control simple actuators. It uses Microworlds Logo programming language and it works only when it is connected to the computer.

The programmable bricks, Crickets Logo Board and GoGo board share are all targeted to children's education. They are toys that include mechanical parts, and the development environments are based in the concept of visual programming with the Logo programming language. They are very limited systems for activities involved in physical computing, but lack the flexibility required for general purpose applications.

Nylon is a system created at the Aesthetics + Computation Group at the MIT Media Lab by Megan Galbraith, Justin Manor and Simon Greenwold. It is a programming environment and language called Nylon that lets users write the controlling code for programmable devices in addition to developing dynamic graphics. Nylon builds off Design by Numbers (DBN), in that it was designed for artists and visual designers. Nylon and LogoBlocks are each very powerful and are used in a variety of educational settings (Galbraith, 2003).

The Nylon system is based on the Netmedia's BasicX microcontroller; the programming environment uses the Nylon language.

The Nylon system has an interesting design in terms of its form. It comes covered on one side with a board made of nylon (which gives it its name). On one side the name is embedded in plastic on the board; on the other side it is covered by a breadboard where people can quickly prototype things just by adding and connecting wires from the microcontroller terminal connectors to the breadboard. No internal components are in contact with the exterior, but it can be taken apart as needed. Because of the design, it can easily be embedded into

different things, like clothes, pockets etc. making it an interesting option for different prototyping situations. It also has a battery connector inside, so a 9-volt battery can be plugged inside the package with no extra or bulky space needed. The model is very interesting as it is a clear attempt to make a self-contained unit for both programming and prototyping with electronics, which comes close to being true desirable environment for a school. The programming environment offered support exclusively for the windows operating system. Internally the Nylon language was translated into Netmedia's flavor of the BASIC language and then downloaded to the device using the proprietary BasicX programming tools which are only available for the Windows operating system. This limited the possibilities for expansion for the Nylon language and the system itself, as well as the possibilities for further distribution. Because it was mostly targeted to create graphic applications within the Hotpants device, the Nylon programming language included commands for drawing basic form elements like lines, dots, circles, etc.

The Hotpants device created in the Aesthetics + Computation Group at the MIT Media Lab by Simon Greenwold, is a 10 X 14 LED array display device for the Nylon system . It renders graphic commands sent to it by the Nylon base unit. Hotpants is powered by a PIC microcontroller, making it capable of considerable onboard processing. All necessary information to build Hotpants is available for public use from its web site. The necessary tools to build it are freely available as well. It can be used independently from the Nylon system, making it possible to connect to other devices by implementing the necessary commands. While the Hotpants display was available to the public, the Nylon board was not. It was only used at the MIT Media Lab in diverse workshops and classes.

Zuf is a programming system created at the Aesthetics + Computation Group at the MIT Media Lab by Megan Galbraith for controlling small embedded devices and microcontrollers using fuzzy logic. It was designed and targeted for fashion designers interested in building computational garments. It is a web-based development environment, and visual programming oriented. At the moment it is not completely developed or available to the public, but it is a very interesting concept that tries to provide a complete tool for fashion design audiences in both hardware and software terms and take advantage of the web as a programming environment to make it platform independent and widely available.

AvrMini is an application/development board designed by Pascal Stang at Santa Clara University that is used for class exercises and workshops. It is general-pur-



Hotpants  
Simon Greenwold, 2002

24



AvrMini  
Pascal Stang, 2002

25



Programma2003  
Massimo Banzi, 2003

26

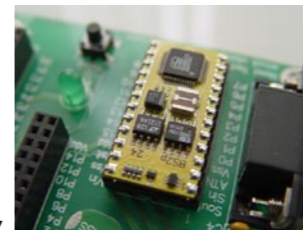

Parallax BasicStamp  
Parallax Inc, 2000.

27

pose and provides access to all the microcontroller's ports with headers. It allows one to rapidly prototype and test new applications for the AVR microcontroller. It is a very affordable and simple system, generic enough to be used for different purposes and start up testing of prototypes. Pascal developed a series of libraries in C that simplify common use tasks. It is a very interesting system and it is completely based on GNU tools for its programming. Because the programming language is C it requires a good understanding of C and UNIX to use the available tools. This has been widely used in the Human Computer Interaction Design program at Stanford University by Professor Bill Verplank.

Programma2003 is a prototyping board created by Massimo Banzi at Interaction Design Institute Ivrea; currently it is used to build simple interactive artifacts and as a teaching tool for the Physical Interaction Design classes at the Interaction Design Institute Ivrea. It uses the Open Source JAL programming language and the popular PIC16F876 Microchip microcontroller. At the moment the JAL language is very limited and it is oriented to engineering audiences. The support is limited as well; since the only source of information is its own creator, making it difficult and cryptic to be used as a teaching language and to illustrate the concepts of programming to audiences with no previous experience in hardware or programming. It is an attempt to offer a free platform, based on freely available tools for the Windows, Mac and Linux operating systems.

### 2.3. Contributions from the industry

There are companies that have targeted their products to intermediate and beginner level users, and have invested time and effort in developing educational material as well as support and community. I will describe some systems with this orientation.

Multiple factors are involved in choosing the right platform for an application that is general enough to respond to the necessities in diverse kinds of projects. Price, power, memory, ease of use, freely available tools, support, programming languages, and which operating systems are supported are all very important to the choice.

Parallax BasicStamp is a very popular microcontroller. There is a vast source of information, code, examples, experiments, support, user groups and material available. It is sold as part of basic kits for beginners and education or as a stand-

alone product for experienced users as well. The kits include a board, microcontroller, sensors, motors, and complementary electronic devices and companion book to develop experiments.

Netmedia BasicX is NetMedia's family of rapid development micro-controllers. These products include the BasicX-01 Developer Station and chip, and the BasicX-24 Developer Station and microcontroller chip programmed in NetMedia's version of the BASIC Language. Around it, the company developed a set of devices like LCDs and servo motor controller boards and there is also a vast number of resources available on-line, as well as user groups, examples and documentation.

Both BasicStamps and BasicX include an integrated development environment (IDE) only available on the Windows operating system. These systems are very expensive and fragile for educational purposes, but the availability of materials and support online make of them an excellent choice for beginners and hobbyists, and the classrooms of some schools. The programming environment is not freely available, as users have to purchase it (included) with the hardware. Both BasicStamps and BasicX are programmed in variations of the BASIC programming language which nowadays is far from being a widely used language and lacks the structure, elegance and level of abstraction of languages like C or JAVA. This makes it difficult to be used in other environments and to create reusable or portable software. It is clearly not the right option for teaching and learning the concepts of programming.

Microchip PICs are a very popular family of microcontrollers. Hundreds of models are available for different needs, as well as on-line support materials, examples, and documentation. They can be programmed in a variety of languages, from assembler, C and BASIC, as well as open source languages like JAL. The low price makes them a very interesting option for prototypes, but unlike the BasicX or BasicStamps which are products almost ready to use, they need some special initial setup for both hardware and software. They require hardware initialization programmers, which are hardware blocks designed to download programs to the device to start it operating. This needs a deep understanding of technical concepts and processes. This family of microcontrollers became very popular due to amateur radio and hacking communities, as they were widely used and spread in the hacking of satellite signals.

Atmel AVR and ARM microcontrollers are both very inexpensive and powerful, but both have a large source of on-line resources, examples and documentation;

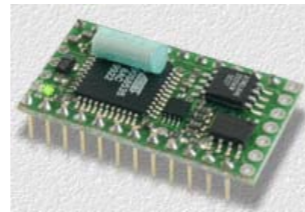

Netmedia BasicX-24  
Netmedia, 2001

28

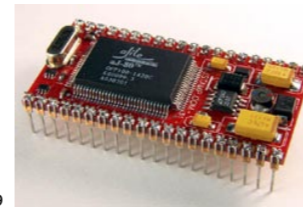

Systronix JStamp  
Systronix, 2002

29



Dallas TINI  
Dallas Semiconductors, 2001

30



Parallax Javelin Stamp  
Parallax Inc., 2003

31

and a variety of programming languages. There is a free C (GCC) compiler for these systems, as well as commercial tools to program them. Both are available as standalone components, but also embedded in many different kits offered by different companies. Both are targeted to intermediate and advanced users who have a good knowledge of hardware and programming, so they have been widely used in engineering schools, but are not very popular in art and design educational environments.

Systronix Javastamp is a microcontroller based on the Ajile family of microcontrollers. These are programmed in the Java language, and recently have started to be used in engineering schools. There is a variety of kits available around this product: TStik, JStik, JCX, JStamp, JSimm, JDroid, and JRealTime, depending in the user's needs and budget, but in general they are expensive devices, and difficult to use for beginners or non-technical users, due to the intricacies of Java programming and the offered set of instructions.

An integrated programming development environment is provided with the Kits and Java programs can be compiled with any Java compiler but the linking and download into the chip can only be made through using the proprietary Integrated Development Environment (IDE) software which is not freely available or distributable and is included with the purchased device.

Dallas Semiconductors TINI is a system that provides the possibility to design hardware devices able to connect to networks or the internet. It is mostly designed to use 1-wire interface products (sensors and actuators), making it difficult to use with the simple, cheap and widely available ones. There is an evaluation board available for testing and development and it is programmed in the Java language. Users can use standard SUN Java development tools or the ones of their choice. This system is pretty much a computer, with web server, serial port, Ethernet port and an operating system. It is a very interesting option for networked and advanced projects, but despite the price, additional circuitry is necessary in order to interface it with regular components, so is not the best option if used in simple applications or in a classroom by beginners or non-technical users. Once it is installed, it can be programmed from different platforms through the network interface.

Parallax Javelin Stamp is the same size package and electric configuration as the BasicStamp. It is programmed in the Java programming language and it is based in the Uvicom microcontrollers. Online community and support are also avail-



able and a simpler programming and wiring model than the Dallas TINI microcontroller makes it better for beginners, but it is difficult for them when it comes to the programming. It is possible to use different Java compilers to compile the Java code but as the Systronix JStamp it is necessary to use the proprietary IDE to link and download the compiled program into the chip. Kits are available for this microcontroller for beginners, but it is also possible to get it as a single unit. There are no free software tools for this platform.

Makingthing's Teleo is a modular set of components for building things with electronics. It is a system designed to connect modules that add functionality to the projects through a 4-wire interface peer-to-peer network. It can be interfaced to the Max/MSP software, as they provide objects to add its functionality to the MAX software. The modules are based on the PIC 18 family of microcontrollers; it provides MOSFET switches, which are devices able to switch larger currents and voltages than the microcontroller can by itself. It is designed to span mechanical hardware and multiple applications. The system is very expensive for teaching purposes, and also the MAX software must be purchased to program it in a graphical way. The Teleo system uses a very interesting model of modular architecture so modules can be added and interconnected as necessary.

The Infusion I-CubeX Digitizer is a device that translates information into MIDI. People can map the MIDI messages of their choice, controlling their own parameters. It is possible to connect up to 32 controllers. A turn knob can replace the mouse, a light can act as a mod wheel, a touch triggers samples, the temperature controls the volume, etc. It is a black box with inputs and outputs that can connect to MAX/MSP software. It is a very expensive device, and around it, Infusion sells a wide range of very expensive sensors and actuators ready to connect to the box. The price makes it very difficult to deploy in a school, and it is more oriented to professionals who are interested in MIDI interfacing for performances, with no need of complex electronics knowledge.

Pond Electronics designed a board based on the PIC16F876, as well as on the BasicStamp microcontrollers. They also designed a series of interface boards for these systems, providing a standard PCB format and a stackable I/O bus interface, which is very interesting for expanding hardware systems on demand.

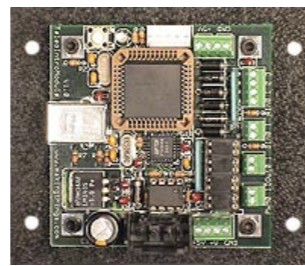

Makingthings Teleo  
Makingthings, 2003

32



Infusion I-CubeX  
Infusion Systems, 2001

33

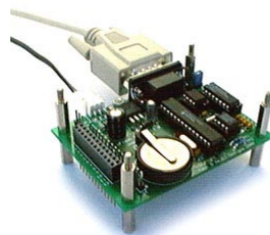

Pond PIC Ultraflash Board  
Pond Electronics, 2003

34

## 2.4. Contributions from Physical Computing classrooms

Finally I will mention the contributions of individuals and schools to the physical computing and electronics prototyping community. Many people have amazing web sites full of information, sample code, diagrams, documented experiences, recommendations and step-by-step guides. I will reference some of these people and their web sites, as they are relevant for this research.

Durrel Bishop's work at the Royal College of Art and IDEO, ideas and methodologies, have been extremely influential in the development of physical or tangible computing. He is very interested in designing electronic objects that are self-descriptive of their behavior and how to augment non-electronic objects by giving them new properties.

Dag Svanaes has done research on the nature of interaction as well as in designing teaching curriculums and tools for teaching interaction designers with analysis from very different perspectives; his work has been very influential in the interaction design community. He designed software tools for designers to prototype graphical user interfaces by drawing with pixels with inherent behavior: Interactive Pixels.

The Interactive Telecommunications Program (ITP) at New York University (NYU) has been extremely influential in physical computing. It started with Dan O'Sullivan's Physical Computing class, and has been involved other people as it have been growing in the last few years. Dan's home page, as well as Tom Igoe's on Physical Computing (A Hands-on How-to Guide for Artists), are well known resources on the internet. The amount of available material and references in their web site is quite considerable. The information available covers a vast range of topics, like doing basic electronics, programming, serial communication, video, MIDI, hacks, tutorials, guides for interfacing commercial and free software and hardware and software libraries made by them and their contributors to provide connection between different technologies and solutions. All this targeted to support artists taking the physical computing class. Bill Verplank at Stanford University has been also very influential in the field with his individual work and research as well with the Human Computer Interaction class. He taught the Physical Interaction Design class at Interaction Design Institute Ivrea in collaboration with Massimo Banzi, who also leads physical computing workshops for students in schools in Italy.

SenseLab at UCLA, the Electronics Laboratory for the UCLA Design | Media Arts Department, is an active source of resources for learning to prototype with electronics, and knowledge dissemination and sharing.

Most teachers have chosen a commercial platform, commonly BasicStamp and BasicX microcontrollers. This decision was driven by convenience, availability of materials, support, easy of use and basic features, rather than appropriateness to a particular teaching programming or concepts in basic electronics.

It is well-known from the experience in the physical computing classes that students, especially those coming from non technological disciplines, become attached to the platform they learn from and continue using it. Because these students don't have technical or programming backgrounds, they invest time and effort in learning how to use and program these devices; commercial products that are not meant to teach or illustrate the concepts behind programming or electronics. The structure and tools provided are attached to specifics of a technology, making it very difficult for students migrate to others, when the one at hand is not the most appropriate solution for their explorations. If these audiences are willing to invest resources in learning such things, it makes sense for them to learn concepts that can be used and mapped in different environments and technologies, rather than learning the specifics and intricacies of a product.

Another important consideration for schools and students is the availability of these tools for public use and distribution, at least in academic environments and applications.

*When appropriate, it is necessary to give students real computing skills, not only proprietary software "directions for use." Consequently, they should get unrestricted access to the source code, modify or adapt it to their own needs, and thus improve the applications they use or develop.*

*Free Software is particularly performing and secure for communication, a priority at school for Internet access and E-mail. Free Software allows remote servicing, a necessity for its deployment in large schools. Free Software allows software perennity as there is no necessity to buy the last software releases to obtain an (eventual) improvement. Updates can be immediately developed (so users don't depend on editor goodwill) and shared with other users worldwide.*

*Knowledge is universal, Free Software too. In Education, means are more limited than in other sectors, because they have to be employed on a large scale. It's more relevant to pay grey matter (e.g. help for projects conception, personal and educational training) or extra devices than to pay proprietary licenses. (Free Software Foundation 2003)*

## 3. Concept development

I had the opportunity to collaborate with Ben Fry and Casey Reas as part of the Processing development team. I also use Processing on my personal activities and as a teaching platform for teaching an Introduction to design for electronic media at the University of Los Andes in Bogotá, and have also taught diverse Processing workshops in different parts of the world.

Processing, as a subset on the Java language, brings to users an application interface independent from the technology in which it is used, maintaining a level of abstraction that allow users to learn the basics of computer programming and focus on their projects rather than in technical issues or the technology specificities of a platform. The Java programming language offers a syntax which is very similar to C, C++, Javascript or Flash Actionscript, making possible to build programs and algorithms that can be easily translated to different languages and environments. This makes of Processing a very interesting tool for teaching and learning computer programming.

Large distinctions between Processing and Java are the Processing graphics library and a simplified programming style that doesn't require users to understand more advanced concepts like classes, objects, or animation and double-buffering (while still making them accessible for advanced users). Such technical details must be specifically programmed in Java, but are integrated into Processing, making programs shorter and easier to read. (Reas, Fry, 2003)

With Processing there is a community of 5000+ artists, designers and programmers around the globe, as well a group of educators, using Processing in their teaching curriculums in art and design schools. I found inspiring and of great value to build on this work. A large number of workshops have been taught around the globe, allowing the development team to gain the experience that permitted the refining of the teaching materials and curriculums, and collecting feedback on the API and environment for further development. How could I ex-

tend this experience to hardware programming and prototyping with electronics? I started to explore a number of technological alternatives trying to find the most appropriate ones.

To start the explorations, I conducted a series of experiments with different technologies guided by intuition, excitement and a hands-on approach. At the same time, looking into the kind of applications where microcontrollers are used, I tried to identify the basic features of a desirable system. After long discussions and thoughts I decided to call my system Wiring. The following are my experiments with different technologies that led to it.

### 3.1. First Experiment

Based on my own experience and other's works I started to think of what could be the basic desirable Application Programming Interface (API), which is the set of commands or instructions available to users in a programming environment to create their own programs.

Processing compiles the user programs (code), which is a subset of the Java language, and produces an application. By pressing the play button, the resultant application can be seen manifested on the screen, and it can respond to different input devices connected to the computer. Another possibility is to export the user's program to an applet, which is an application that can run inside a web browser as part of a web page. Processing generates the necessary files to post the user's program code and the application to the web, including the basic HTML document.

The idea was to generate an API as close as possible to Processing, at least in the basic set of commands, maintaining the concepts and coherence used in Processing, to create a new set of commands to support Wiring. Because of this, the Wiring language could be immediately used by the existing Processing community.

As my first experiment I naturally started to look at Java programmed devices, if there are not so many, I found some interesting devices to analyze.

I concentrate in studying 2 cases: the Parallax JavelinStamp, and The Dallas Semiconductor's TINI Board. I contacted Dallas Semiconductors and Parallax Inc. explaining the purpose of my project, and ask for their possible collaboration. Dallas Semiconductors arranged shipping of a TINI microcontroller as well as the socket board, with discount from the retail price. Parallax Inc. also offered discount and assistance in getting one of their devices.

As a technology enthusiast I found the Dallas TINI board very interesting, its capabilities to connect to the network are quite amazing. It is a very powerful microcontroller, almost a small computer. Users can run a web server, and can also connect to it from the network; it can also be connected to the computer's serial port. Once it is up and running, the users can modify their programs and then they can be sent to the board via FTP.

The board is mostly designed to be interfaced with one-wire devices, which are a set of sensors and actuators that operate with literally one-wire connection and use a special protocol for that—but I found that connecting an LED and to make it blink is quite difficult—and this usually is the first exercise for interaction design students.

The TINI microcontroller has a Java API very similar to the standard Java, with additional instructions to support its functionality. It uses standard Java classes, which are basically the Java compiled files and then these are linked into a binary file that can be uploaded into the board. Programmers can use the Java compiler of their choice to compile their programs, but the linking is achieved through the Dallas tools.

It is very difficult to use as a platform for teaching physical interaction design. The SIMM and the board are quite big and expensive even before the user's circuitry is added for creating a prototype, but no doubt they are very interesting hardware for advanced or very specific purposes.

I received the Parallax JaveStamp also known as Javelin Stamp. As a product from Parallax, which already has a long experience in the educational and hobbyist market, it seems closer to the well known Basic Stamp. In fact, it is compatible in terms of pin functionality with the BasicStamp.

I mounted the microcontroller in a board and started to do some programming on it. The programming environment is available only for Windows, and it is not free; users buy it and have the right to use it when they purchase the device.

Internally from the development environment it calls for the GNU IBM Jikes Java compiler; it uses an old version of Jikes because of class files compatibility. I tried to use newer versions of Jikes and the generated files don't work with the Parallax linker.

The class files are linked later with the libraries to produce a binary file that can be downloaded into the microcontroller. The linker is the intellectual property of Parallax, and it is not open source. Nonetheless I was very interested in this de-

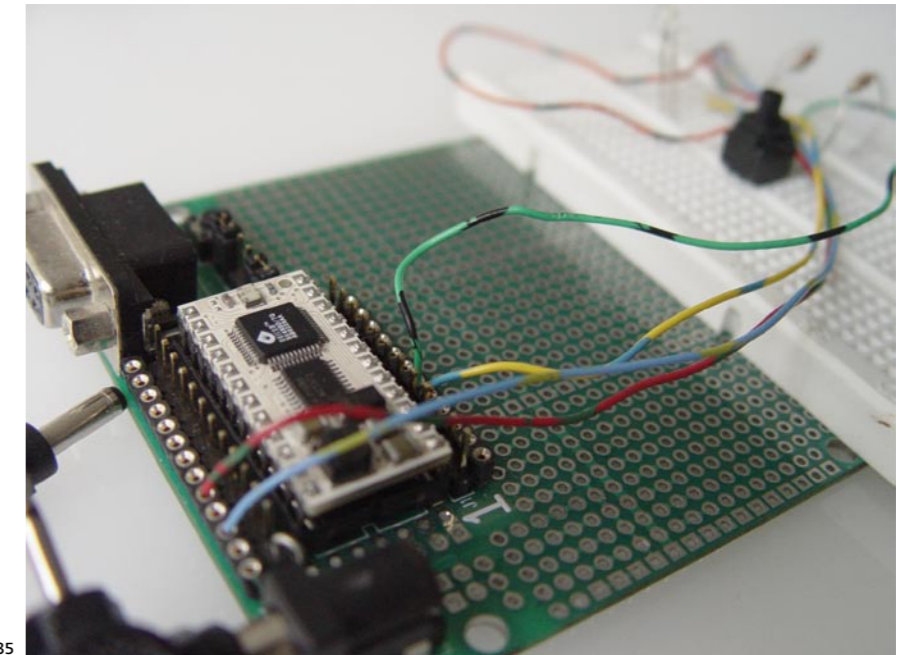

35

Parallax Javelin Stamp initial setup

vice and asked its manufacturers for support. They collaborated, and responded to my inquiries by creating command line tools (separating some commands from the programming environment) to link and download the program to the microcontroller.

So after this experiment, I decided to take my chances and do the first attempt to integrate between the Processing environment, the created API and this microcontroller, which meant that, users should be able to write their programs in the familiar Processing environment, using the instructions and commands proposed for the Wiring language, then compile and download the code to the microcontroller and, if lucky, see it working by some kind of blinking light.

A few weeks later finally some stable application resulted. It seemed to be working, and it was very exciting to see what this could be for users if they were able to write code for their experiments in this way. So this encouraged me to continue further.

I made no change to the processing interface for this experiment; only changes in the buttons' functionality were made. The Play button was used to verify (compile) the user code, and the Export button was used to compile, link and

download the program into the microcontroller. It also generated an HTML template with the user code to be posted on the web that could be edited later to add images, diagrams, etc.

After the initial Windows support from Parallax, I asked them for the possibility of having the command line linker and downloader available for Mac and Linux. (As I write this paper I still don't have an answer from them.) This first experiment was done without regard for future possibilities of distribution of their proprietary software but more driven by the excitement of doing it. Nonetheless I have to thank them for their support. They would be interested to support this kind of project in the near future, but as they are developing their own platforms, their time frame was too slow for me to use their technology in my research.

Unlike programming the Parallax BasicStamp, the programming for the Javelin Stamp is more difficult for beginners, regardless of whether it is worth pursuing to learn to program in Java.

Conclusions after this experiment:

Java programming for the microcontroller is a very interesting option to build upon. It has the possibility of easily extending the available command set by programming in Java.

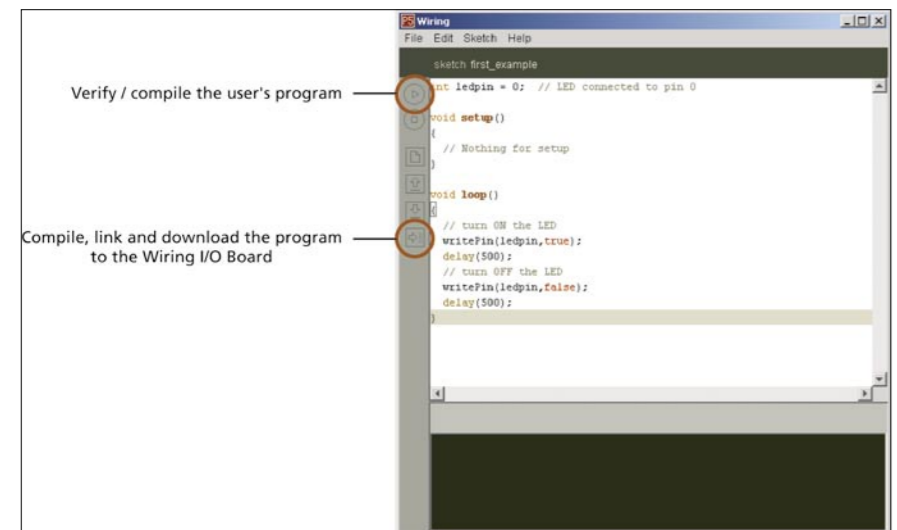

36

Functions assigned to buttons in the Processing interface

After this experience I continued examining other Java-based microcontrollers, including devices that seemed to run native Java code. All of them at the very end use a linker and downloader that usually is property of the manufacturer, which in all cases is only available for Windows and some with a licensing scheme that could prevent the future distribution of this project.

For this experiment I built two examples, one a blinking light and the other a switch input, which are explained in detail in the second experiment, since they were repeated using a revised version of the Wiring language.

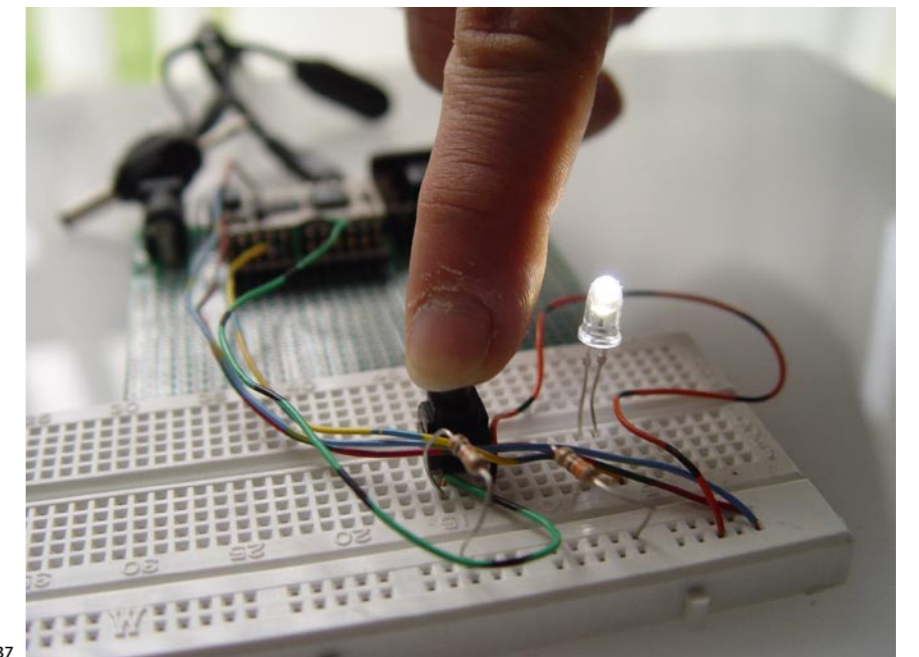

37

Parallax Javelin Stamp press button example

### 3.2. Second Experiment

The next thing I did was to analyze the balancing of the microcontroller capabilities and the availability of free tools. I analyzed some of the most widely used microcontrollers, and two families of chips seem promising, ARM-based microcontrollers and AVR microcontrollers. I choose to work on the ARM microcontroller for the next experiment. Many companies manufacture ARM based microcontrollers, among them Phillips and Atmel. Based on their response to my requests for help, I started with the Atmel ARM version, specifically on the AT91 R40008 microcontroller.

I got the evaluation board, which basically consists of an electronic board with the microcontroller soldered to it, switches, LEDs, serial ports and I/O pins ready to be used, so that I could concentrate on the software development rather than in building an initial electronic circuit for testing.

After building the necessary tools to compile programs for this platform, I started porting part of the Wiring commands (API) to the specifics of the ARM in the C and assembler languages, initially the most basic ones. From the previous

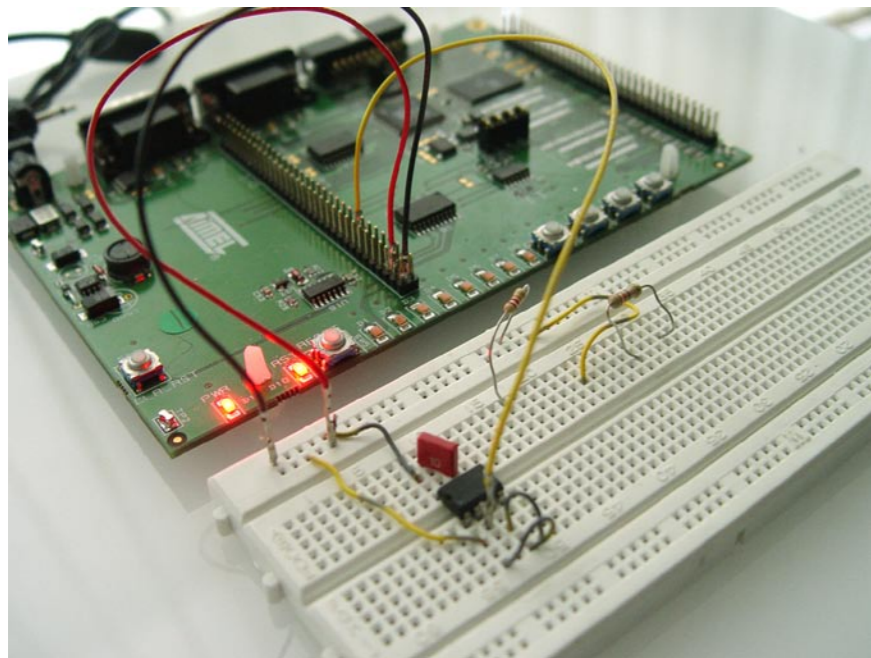

Atmel ARM Evaluation board  
Atmel Inc., 2003

38

experiment I changed some of the commands in the API to be coherent with Processing style and making more sense for the user. After programming the basic set of instructions, I made a set of examples using the Wiring language. In the mean time more evaluation boards arrived, among them Microchip PIC, AVR Atmega128 and samples from other devices.

#### Example 1: blinking LED

This example simply shows how to make an LED (which is basically a light) to blink (turn on and off) every half a second. The LED is connected to pin number 6 according to the diagram.

```
int ledPin = 6; // LED connected to pin 6

void setup()
{
  // Nothing for setup
}
void loop()
{
  // Sets the LED on
  digitalWrite(ledPin, HIGH);
  // Wait for half a second
  delay(500);
  // Sets the LED off
  digitalWrite(ledPin, LOW);
  // Wait for half a second
  delay(500);
}
```

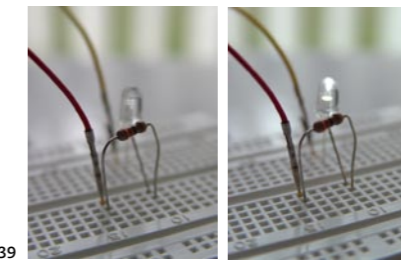

39

Blink LED

### Example 2: LED swing

This example shows in a row of 8 LEDs how to make them light one at a time in a sequence, giving the impression that the light moves from one to the next. When it reaches the last one it comes back to the first one.

```
// which pin is currently used
int which = 0;

// User defined function to turn off all the LED
// connected from pin number 0 to pin number 7
void turn_all_off()
{
  int i;
  for(i=0; i<8; i++)
  {
    digitalWrite(i, LOW);
  }
}

void setup()
{
  // Nothing for setup
}

void loop()
{
  // Turn all LED off
  turn_all_off();
  // Set on the actual LED
  digitalWrite(which, HIGH);
}
```

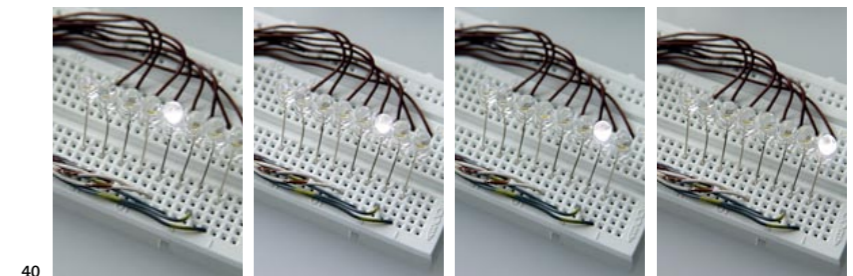
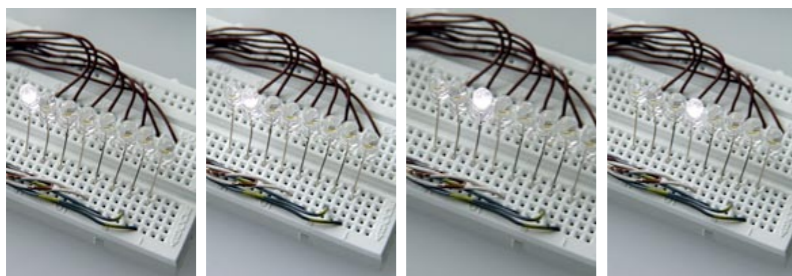

40

Swing LEDs

```
delay(200);
// Move to the next one
which = which + 1;
// If reached the last one go back to the first
if (which >= 8)
{
  which = 0;
}
}
```

### Example 3: An LED blinks while the user presses a switch

This example shows how to read a switch which is the most basic input device. It blinks an LED while the user presses a switch. When the user releases the switch it turns off the LED.

```
int direction = 1; // Used for the blinking
int switchPin = 12; // Pin attached to the switch
int ledPin = 6; // LED on pin 6

void setup()
{
  // Sets switch pin as input
  pinMode(switchPin, INPUT);
}

void loop()
{
  // If the switch is pressed blink the LED
  if(digitalRead(switchPin) == LOW)
  {
    digitalWrite(ledPin, HIGH);
    direction *= -1;
  }
}
```

```

// Alternate between on and off the LED
if (direction == 1)
  pinWrite(ledPin, HIGH);
else
  pinWrite(ledPin, LOW);
delay(200);
}
// If not pressed, turn off the LED
else
{
  pinWrite(ledPin, LOW);
}
}
}

```

**Example 4: Controlling a screen-based application running on a PC through touching an object.**

This example shows how an object becomes a very simple interactive device to control a screen-based application running in a remote PC. Basically the PC is running a graphic application, which receives input from the serial port. The PC's serial port is connected to the microcontroller's serial port. The microcontroller is waiting for user input and when the user presses the object, it sends a signal through the serial port causing the PC's running application to react by changing the shape and movement of basic graphic forms on the screen.

In order for the microcontroller to detect the event of touching, it has connected a touch sensor to one of the pins. The touch sensor acts as a simple switch, which is turned on when the user touches an electrode and off when the user releases it, so the electrode is inside the interactive object.

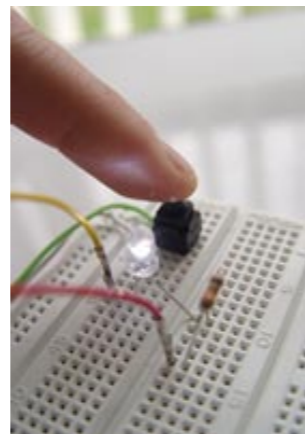
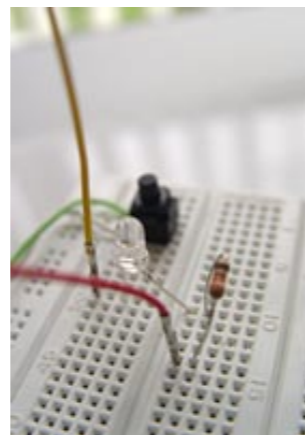

The LED blinks when the switch is pressed

41

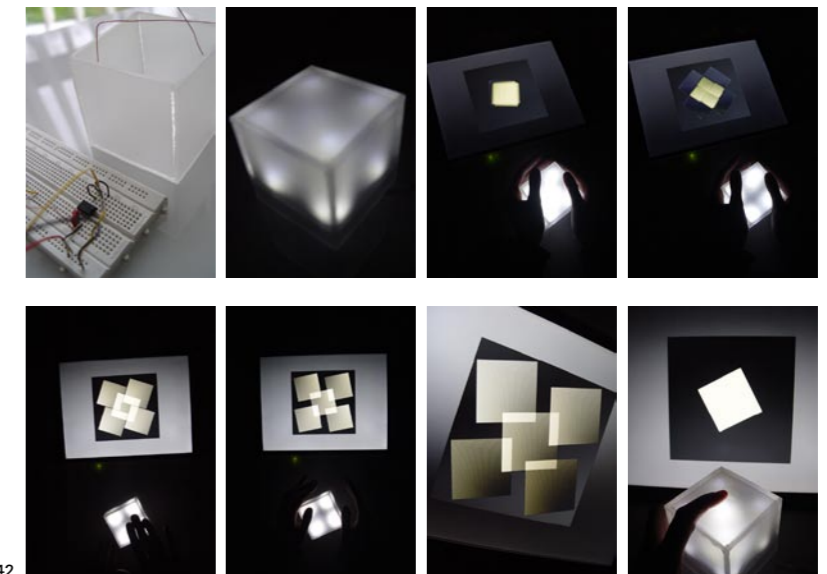

42

Controlling a screen-based application

```

// Touch sensor will be attached to pin 23
int touchSensor = 23;

void setup()
{
  // Starts the serial port with default settings
  beginSerial(9600);
  // Sets touch sensor pin as input
  pinMode(touchSensor, INPUT);
}

void loop()
{
  // If the user touches the object sends a '1'
  // and waits until he stops touching
  if (pinRead(touchSensor) == HIGH)
  {
    serialWrite('1');
    while (pinRead(touchSensor) == HIGH)
    {

```



```

    delay(500);
}
// When the user release the object send a '0'
// through the serial port to the PC to indicate the object
// was released
serialWrite('0');
}
}

```

ARM microcontrollers are very powerful devices. In some setups they require additional peripheral electronics. For the next experiment, I scaled down the microcontroller to the Atmel AVR microcontrollers family, all of which are still powerful but less expensive.

### 3.3. Third Experiment

The third experiment consists again of porting and testing the existing Wiring API to the AVR microcontroller, specifically to the atmega128. This microcontroller has a very good balance in terms of power, features and price. I received an evaluation board from BDMICRO. This board provides access to all the features of the microcontroller without adding any extra complex devices.

After some time the API was at the same level as the ARM version. After testing the existing examples, they were made available from the wiring Web site along with the updated API.

By porting the Wiring API to different microcontrollers, patterns started to emerge that will help to support the future development of Wiring for other microcontrollers.



Atmel STK500 Evaluation board

43



DLP Design USB232M Evaluation board  
DLP Design, 2003

44

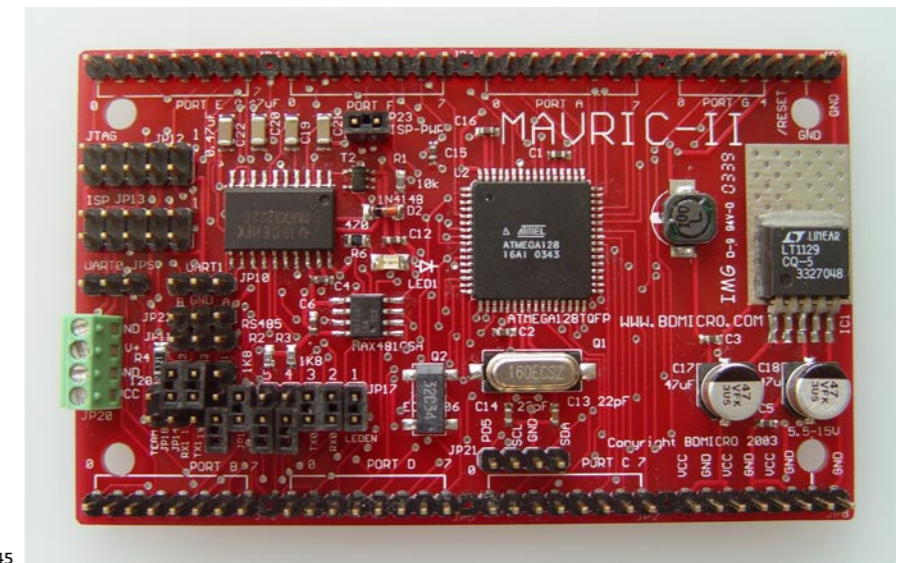

45

BDMICRO MAVRIC-II atmega128 Evaluation Board  
BDMICRO, 2003

I proceeded to implement the analog to digital conversion, digital to analog (PWM Pulse width modulation), pulse generation, as well as some basic libraries, like serial port communication, servo motor, the Liquid Crystal Display (LCD) library, for generic text displays based on the HD44780 controller.

I received an evaluation board for the FTDI USB chip in order to provide support for USB serial connection, since the serial port is a disappearing commodity in the computer market today, especially on laptops. Wiring should support the serial port communication without having to use an external adaptor for it.

FTDI provide drivers for the Microsoft Windows, Mac OSX and Linux operating systems, which are necessary for the Wiring environment to run on this operating systems. The chip worked successfully after running some tests.

## 4. Design and Implementation

### 4.1. Wiring Software

I designed an API, the basic set of commands that are available for users in their Wiring programs developed for their projects and explorations. Many modifications have been made since the original language proposal; maintaining the coherence with Processing and with the concepts that need to be illustrated. As soon as adjustments are made I developed examples that use the new command set. By doing such examples, it helps me to detect which makes sense in the actual set of commands, and quickly make revisions and changes if necessary. This API is available from the Wiring programming environment.

Structure		minute() hour() day() month() year()
; (semicolon) = (assign) () (parentheses) , (comma) // (comment) /* */ (multiline comment) void setup() loop() { } (curly braces) [] (array access) . (dot)	<i>Iteration</i> while() for()  <i>Conditionals</i> if() else  <i>Logical operators</i>    (logical OR) && (logical AND) ! (logical NOT)	<i>Timing</i> WTimer mark() timerEvent()  <i>Pulse Generation</i> beginPulse() endPulse() pulseFrequency() pulseRun() pulseStop() pulseRunning() Pulse Input pulseIn()
Environment	Input /Output	
delay()	<i>Pin Digital I/O</i> pinMode() digitalRead() digitalWrite()	<i>Text Output</i> printMode() print()
Data	<i>Port Digital I/O</i> portMode() portRead() portWrite()	Math
<i>Primitive</i> int float char byte boolean	<i>Pin Analog Input</i> analogRead()  <i>PWM (Analog) Output</i> analogWrite()	<i>Operators</i> + (add) - (subtract) * (multiply) / (divide) ++ (increment) -- (decrement) % (modulo) += (add assign) -= (subtract assign) - (negation)
Control	<i>Terminal Keyboard</i> keyPressed() keyReleased()  <i>Time &amp; Date</i> millis() second()	abs() sq() sqrt()
<i>Relational Operators</i> > (greater than) < (less than) >= (greater than or equal to) <= (less than or equal to) == (equality) != (inequality)		

pow() max() min() ceil() floor() constrain()	Constants  PI ( 3.14159... ) TWO_PI ( 6.28318... ) HALF_PI ( 1.57079... )	Servo Motor Basic servo motor manipulation library  LCD Display Basic LCD manipulation library
<i>Trigonometry</i> sin() cos() tan() atan2() radians() degrees()	Libraries  Libraries extend the basic functionality of Wiring. It is possible to write your own libraries.	DC Motor Basic DC motor manipulation library.  Network (In progress) Sending and receiving data over a net of devices.
<i>Random</i> random()	Serial Supports communication between Wiring and external hardware via the serial port.	more to come...

46

Initial Wiring API

A set of small prototypical examples is being developed to illustrate the basics of the media and the available commands of the language. These examples are available in the Wiring Examples sketchbook distributed with the application and from the Wiring web site Examples section.

From now on all the API changes and Examples will be directly posted and made available from the Wiring web site in the Reference section.

Users can create their programs in the Wiring environment editor. The user's programs are compiled and then could be downloaded to the Wiring electronics I/O board.

Once the program is downloaded to the Wiring I/O Board, it is executed on it.

### 4.2. Wiring Hardware

I designed the Wiring electronics I/O board. This I/O board is based on the Atmel AVR atmega128 microcontroller, which is a powerful, scalable and cost effective.

The board has available 48 I/O digital pins, 8 Analog Input pins and 6 Analog Output (PWM) pins. It also has two hardware serial ports, Two-wire Interface protocol (TWI), In System Programmer (ISP) connector for initial board setup, and JTAG connector available for specialized debuggers. Some pins have different functionality and special functions which is made available through the Wiring

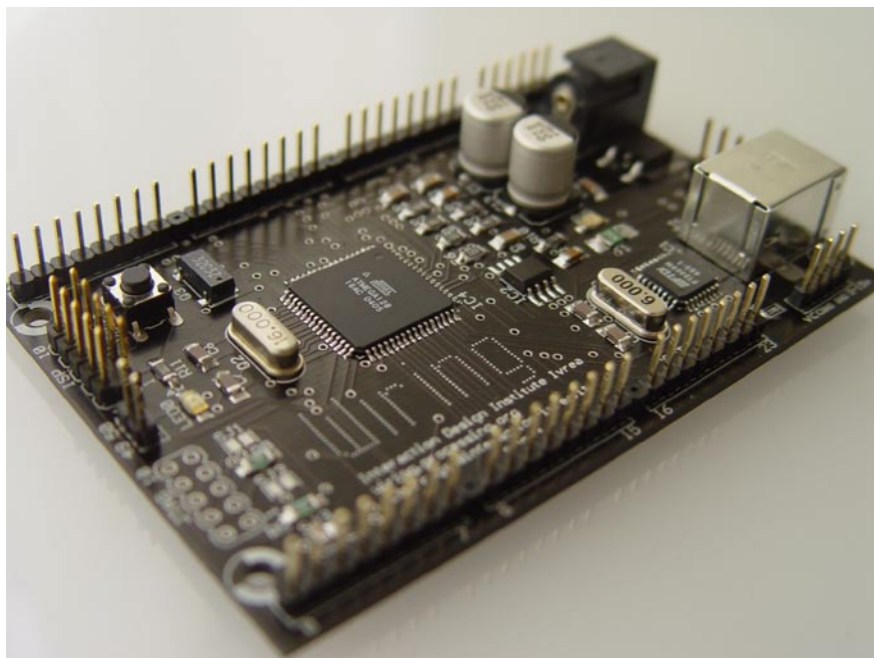

Wiring I/O Board

47

programming environment. Access to the I/O pins is provided through headers. Depending on the application, it is possible to use different kind of headers with the Wiring I/O board: male, female or screw. Headers can also be soldered in the bottom side of the board for special purposes.

The Wiring I/O board can be connected to a computer using any available USB port. This USB port is used for both downloading the compiled user programs to the microcontroller, as well as for communicating the Wiring I/O board with other devices or computers.

The Wiring I/O board can be powered from the host computer's USB port or from a generic positive center Direct Current (DC) power supply adapter that provides from 7 to 15-volt DC. While powered from the USB port, special care has to be taken since the computer's USB bus can only power small, low current consumption devices. It is fine for doing small experiments with LEDs, switches or some sensors, but not to power devices like motors, servo motors, displays, etc. that have much higher current consumption. If this is the case, an external power adapter is needed to power the motors or devices attached to the board. Protection for both the Wiring I/O board and the host computer is provided by means

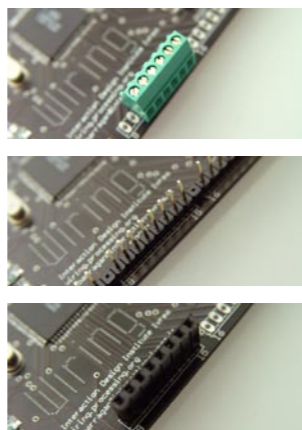

Wiring I/O Board headers: screw, male and female.

48



Standard Servo Motors

49

of a 500mA fuse in the Wiring board. The fuse will break and will have to be replaced if a problem occurs, but will keep safe the Wiring I/O board and the user's computer.

More information regarding these matters will be available on the web site, as well as connecting a wide range of sensors and actuators to the Wiring I/O board.

Several considerations were taken in the design of the board. Since it is a system designed for learning and prototype interaction design projects, it provides access to all I/O pins. Basic sensors and actuators can be directly connected to the board, but more complex elements like a motor will require an external driver for connecting them to the board. What direct functionality to put on the board was a concern for the design of the I/O board. It's been observed that using kits with specific plug-in connectors prevented people to try out other things. By providing specific connectors some kits were limiting the user to what the makers thought they would want to do with them. In Wiring, abstractions have been made in the API; an example of this is the servo motor library. A servo motor is special kind of motor that can only move 180 degrees, so it can go back and forth or stay in a specific position. In order to drive a servo motor it is necessary to send a pulse of a specific length and frequency to the servo motor. Variations of these parameters will cause the motor to position in a specific angle. This is a technological solution that is far from being understandable by users. It seems

#### Servo Motor Library

- beginServo()**  
Starts the servo motor library.
- endServo()**  
Stops the servo motor library.
- attachServo()**  
Creates and attaches a servo motor to an i/o pin.
- position()**  
Gets the servo motor position.
- angle()**  
Sets the servo motor position angle.

more natural to think of an angle and set the position of the servo motor by telling it the desired angle. This abstraction originated the set of commands to control a servo motor.

Sensors and actuators can be grouped in families depending on their basic functioning or communication protocol. Many sensing technologies are based on the variation of resistance through a physical phenomenon, like light intensity, heat, stretch, press, humidity, movement, etc. All these sensors can be read by an analog input pin, and the value read will determine the position, temperature, light, etc. in the appropriate case.

It is the same with binary sensors or devices where the only possible inputs and outputs are HIGH or LOW. In the case of switches or touch sensors ON (HIGH) and OFF (LOW) logic is used. There are sensors like encoders, accelerometers and distance rangers, which work by generating pulses. The length and frequency of the

pulses determine the value of the measured unit. For instance pulses determine speed and direction in the case of the rotary encoder, or X and Y acceleration in the case of the accelerometer. Other sensors work based on communication protocols (like TWI) can be grouped as well by communication protocol. In these cases it makes sense to provide commands to support the protocols rather than the specific sensor when appropriate, and then provide examples that illustrate the use of them. Nonetheless there are some cases in which a library will be a better solution to make the language and the use on the sensor or actuator more understandable for users. The use and the nature of the physical phenomenon that needs to be measured or generated with a sensor or actuator will determine this; but still users will learn the basics of electronics and connection of components, maybe not at the level of an electronic engineer, but enough to be able to use generic components as basic interconnection blocks to add functionality or complement their designs. This stimulates and encourages curiosity and leaves space for the user's imagination about how something can be connected and integrated in their works.

Prototyping interaction design projects often require taking very different technologies and try to put them to work together. From simple standalone or networked interactive objects or devices to prototypes that involve computers or extra external equipment in complex interactive installations. Wiring is flexible and powerful enough to satisfy interaction design prototyping needs. The following diagrams show some physical interaction design prototyping scenarios.

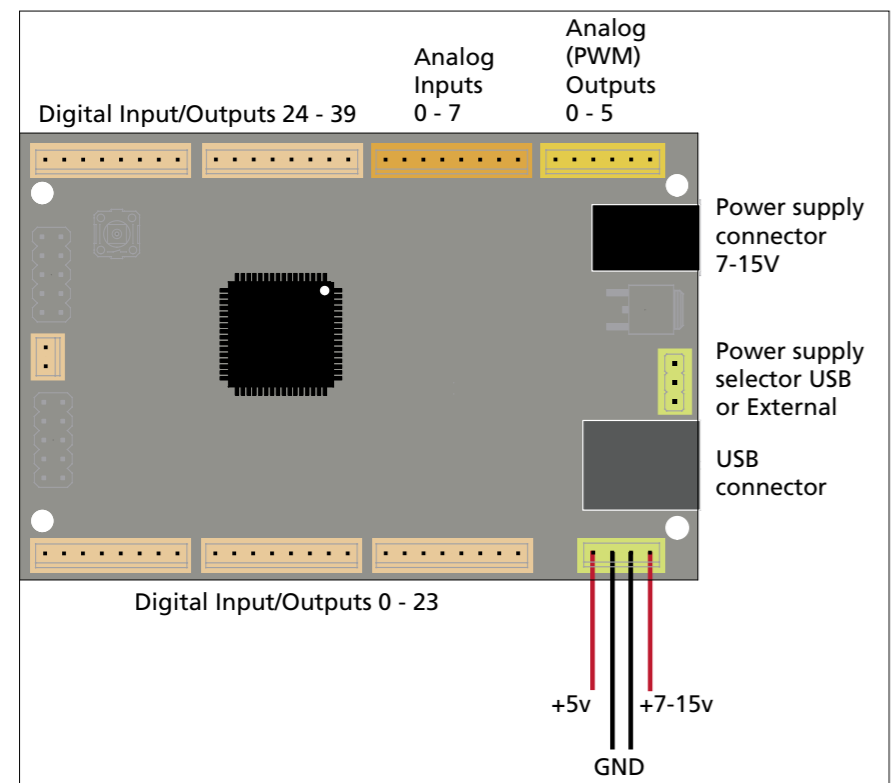

Wiring I/O Board Map



Bend sensor

51

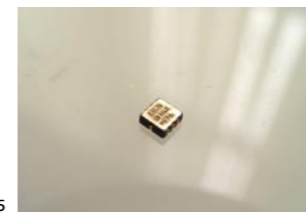

Accelerometer  
Analog Devices Inc. 2003

55



Sharp Ultrasonic Ranger

52



Rotary Encoder

56



Microswitch

53



QPROX Touch Sensor  
Quantum Research, 2003

57



Slider potentiometer (variable resistor)

54

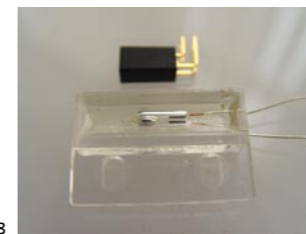

Tilt Switches

58

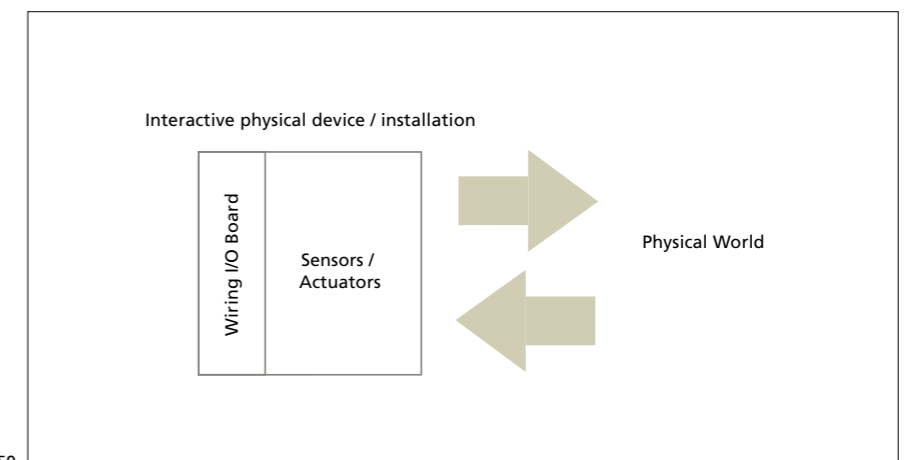

59

Prototyping standalone physical devices or installations

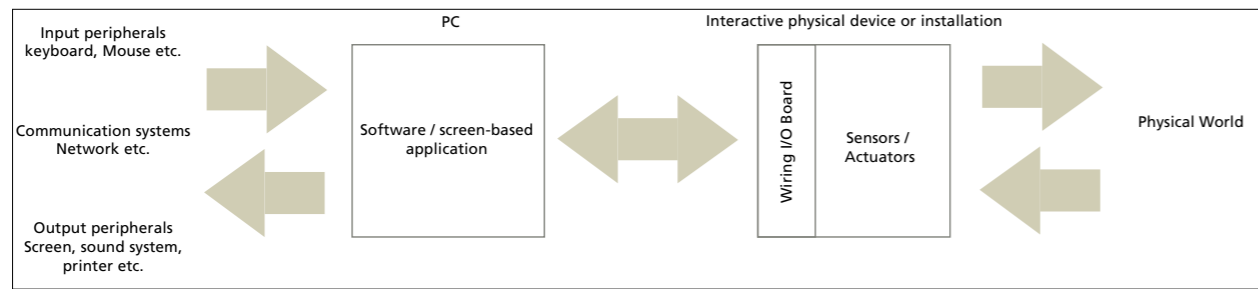

60

Prototyping physical devices or installations including PCs and peripherals

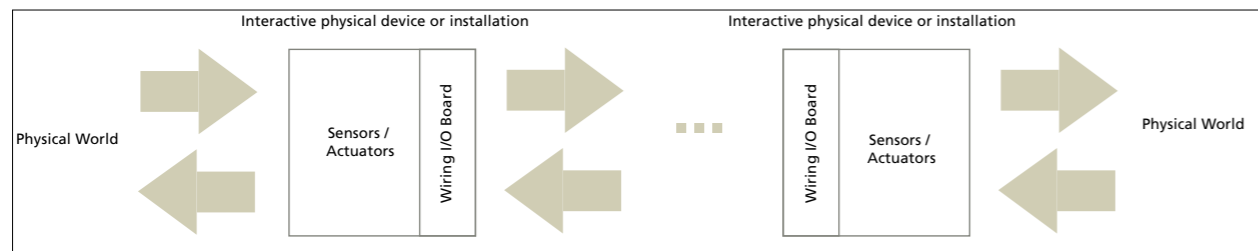

61

Prototyping interconnected physical devices or installations

### 4.3. Wiring Web Site

I designed a web site for Wiring. I started right after the first examples were working. First I designed a typeface exclusive for the project and its image. The Wiring typeface includes 2 families, Normal and Dots; the later is used for the Wiring logo in the web site and the electronics I/O board.

The Wiring and Processing web sites have differences and similarities. This avoids confusing the user, and better suits the differences in the nature of the content displayed, especially in the examples section of the web site.

As in the Processing web site, the Cover section will directly display Happenings, an Exhibition and a few Examples direct links. Also the main navigation bar will link to all sections of the web site.

Now that the Wiring I/O board has come to reality, new sections will be incorporated into the Web site's architecture. These will include all the information related to the I/O Board as well as to basic electronics, sensors and actuators connection, etc.

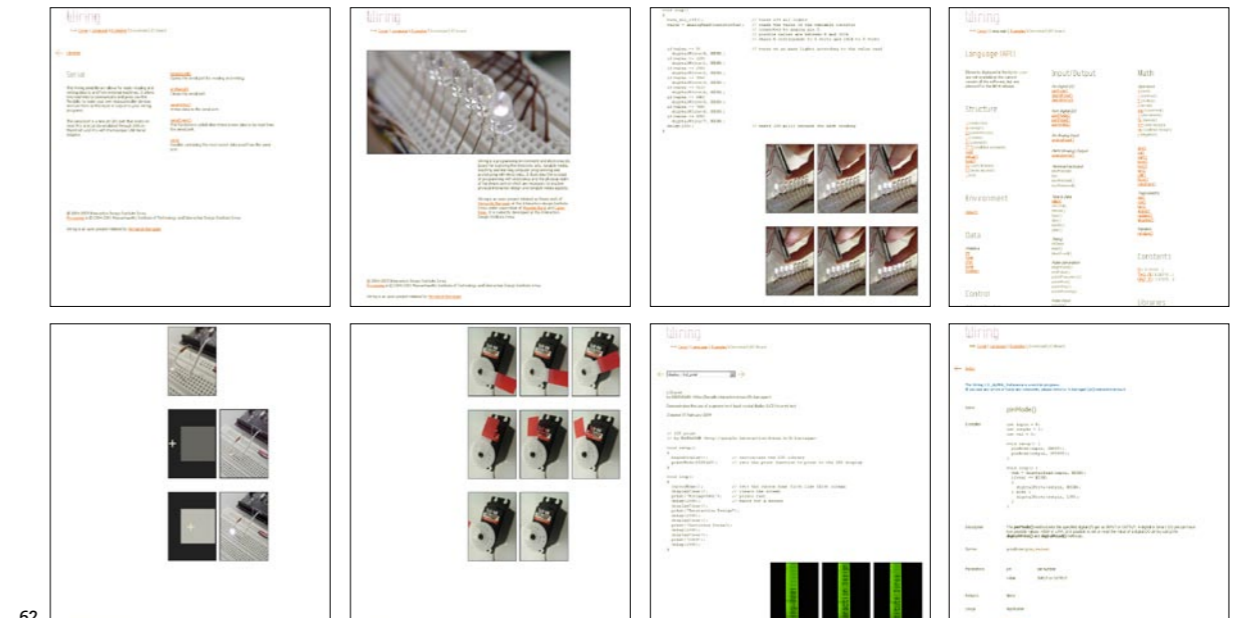

62

Snapshots of the Wiring web site

### Example 5: Light serial

Demonstrates how to read data from the serial port. If the data received is an 'H' turns ON a light, if it is an 'L' turns OFF the light. The data comes from a computer running a Processing program, it sends an 'H' if the mouse is over a rectangle otherwise it sends an 'L'.

```
// light serial
// by BARRAGAN <http://people.interaction-ivrea.it/h.barragan>

char val;          // variable to receive data from the serial
port
int ledpin = 12;   // LED connected to pin 12

void setup()
{
  pinMode(ledpin, OUTPUT); // pin 12 as OUTPUT
  beginSerial(9600);      // initialize serial port
}

void serialEvent()
{
  val = serial;          // get data received in val
}

void loop() {
  if(val == 'H')        // if receive an 'H'
  {
    digitalWrite(ledpin, HIGH); // turn ON the LED
  } else {
    digitalWrite(ledpin, LOW);  // if not turn it OFF
  }
  delay(100);           // wait 100ms for next reading
}

/* Processing code
// mouseover serial
// by BARRAGAN <http://people.interaction-ivrea.it/h.barragan>

// Demonstrates how to send data to the Wiring I/O board, in order
to
// turn ON a light if the mouse is over a rectangle and turn it
off
// if the mouse is not.
```

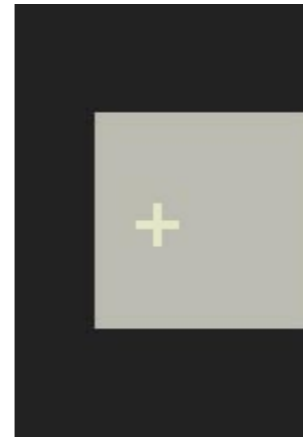
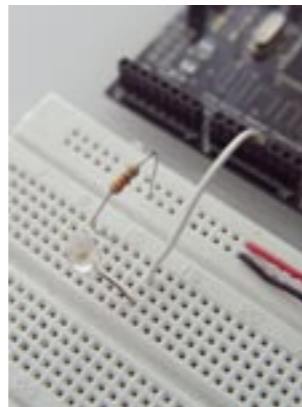
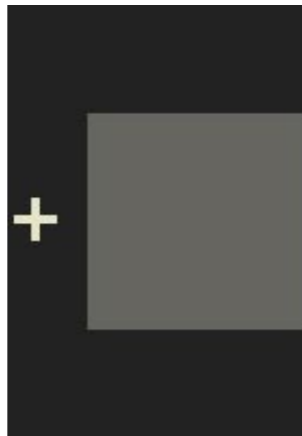
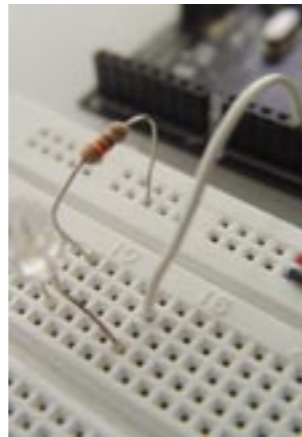

63 Controlling a light from a screen application

```
// created 13 May 2004

void setup()
{
  size(200, 200);
  beginSerial();
  noStroke();
  framerate(10);
}

boolean mouseOverRect()
{
  return ((mouseX >= 50) && (mouseX <= 150) && (mouseY >= 50) & (mouseY
<= 150));
}

void loop()
{
  background(#222222);
  if(mouseOverRect())
  {
    fill(#BBBBB0); // change color
    serialWrite('H'); // send an 'H' to indicate mouse is
pressed
  } else {
    fill(#666660); // change color
    serialWrite('L'); // otherwise send an 'L'
  }
  rect(50, 50, 100, 100);
}

*/
```

### Example 6: Switch serial

Demonstrates how to send data using the serial port. A computer running a Processing program receives the data from the serial port and fills a rectangle according to the value received.

```
// switch serial
// by BARRAGAN <http://people.interaction-ivrea.it/h.barragan>

int switchpin = 0;

void setup() {
  pinMode(switchpin, INPUT);
  beginSerial(9600);
}

void loop() {
  if(digitalRead(switchpin) == HIGH)
    serialWrite(1);
  else
    serialWrite(0);
  delay(100);
}

/* Processing code

// switch serial
// by BARRAGAN <http://people.interaction-ivrea.it/h.barragan>

// Demonstrates how to read data from the Wiring I/O board, in order
// to fill a rectangle on the screen using a lighter color when a
// switch connector
// to the Wiring I/O board is pressed,
// and fill it with darker color when the switch is released.

// created 13 May 2004

int val;

void setup()
{
  size(200, 200);
  beginSerial();
  noStroke();
}
```

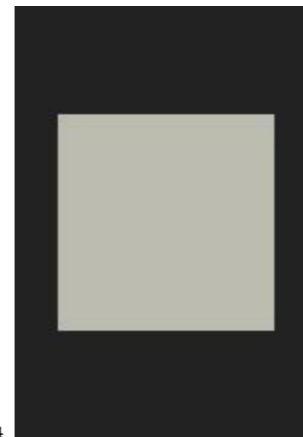
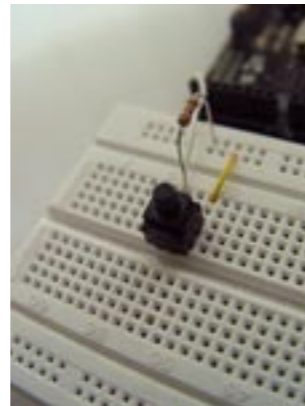

64

Controlling a screen application through a switch

```
void serialEvent()
{
  val = serial;
}

void loop()
{
  background(#222222);
  if(val == 0)
    fill(#666666);
  else
    fill(#CCCCCC);
  rect(50, 50, 100, 100);
}

*/
```

#### 4.4. First users

I started testing the Wiring I/O board and programming environment with one of my classmates, Michal Rinott. After doing some of the basic examples, she developed an example on her own, controlling a servo motor position using a slider variable resistor.

We employed the technique of “think aloud” in order for me to understand her path and direction while doing the examples, to give me insights about the process she follows.

*My experience with Wiring was short but pleasant. My previous experience with coding for electronics was with the BasicX environment and looking over the shoulders of people using the JAL environment. The Wiring environment was very different: it felt simple, clean, aesthetic, non-technical, and not buggy. It seemed to do what I wanted, without any technical monsters lurking behind the scenes waiting for my mistakes.*

*Having used Processing before, I felt comfortable and familiar in the environment. I was surprised at how intuitive the language was, and at how simple it was to get things to work—single command lines made things light up! It all felt very direct I was helped a lot—given the exercises and the exact components I needed to perform them. In this context, and with my prior knowledge, it was quite easy to do things. I got a line of LED's running back and forth - that was quite easy - and then struggled a bit with the border condition: getting the last LED not to “blink” when the sequence changed direction. It was beautiful to see the “for loop” kind of behavior visualized before my eyes.*

*The best exercise was the slider + motor example. It was fun to control a spinning behavior with a sliding—linear motion. It got my imagination running... this could scratch my back! and then more.*

*Peeking into a new language, it was interesting to think about the mental models created by the choice of command terms. The wording would change the way people think about the underlying function. Should the motor be sent an “Angle” command or a “Rotation” command? What would my expectations be in each one of these cases as to what behavior a specific number would invoke? Exciting! (Rinott 2004)*

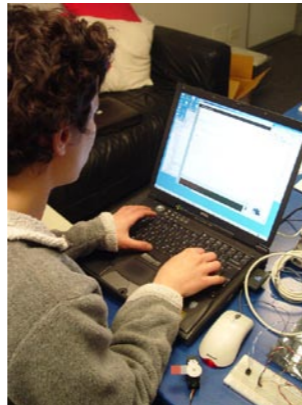

Michal Rinott testing Wiring

65

```
// Controlling a servo position using a slider (variable resistor)
// by Michal Rinott <http://people.interaction-ivrea.it/m.rinott>

int myservo=0; // servo channel 0 to attach a servo.
int servopin=0; // digital pin used to connect the servo
int sliderpin=0; // analog pin used to connect the slider
int sliderValue; // variable to read the value from the analog pin

void setup()
{
  beginServo(); // initializes the servo library
  // attaches the servo number 0 to digital pin 0
  attachServo(myservo, servopin);}

void loop()
{
  // reads the value of the slider (value between 0 and 1024)
  sliderValue = analogRead(sliderpin);
  // scale it to use it with the servo (value between 0 and 180)
  sliderValue = sliderValue/5.68;
  // sets the servo position according to the scaled value
  angle(myservo, sliderValue);
  delay(15); // waits for the servo to get there
}
```

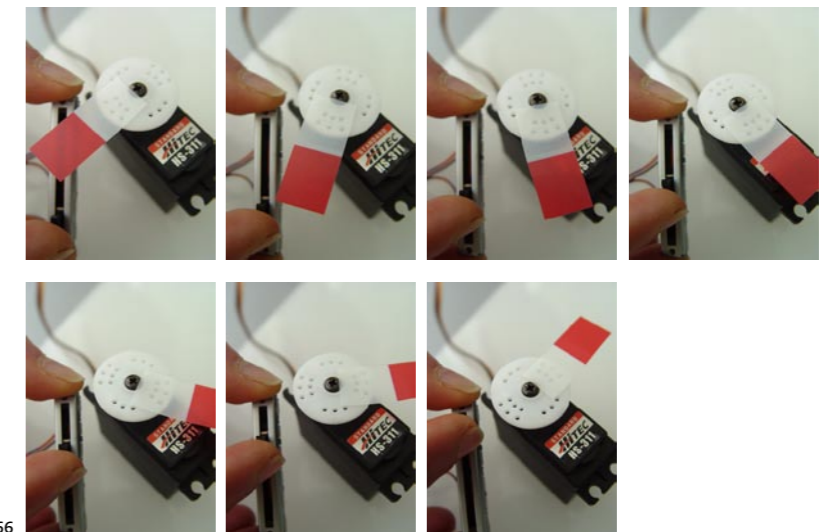

66

Controlling a Servo motor position with a slider variable resistor  
Michal Rinott, 2004



She successfully finished the slider-servo example and it is posted on the Wiring web site's Examples section.

The next user was Karmen Franinovic. She proceeded to do exercises with the existing Wiring examples, and then she started to prototype controlling a light's intensity with a stretch sensor. The stretch sensor is like a rubber band that changes resistance when it is stretched. It worked successfully and again was a experience that provided insights on different aspects. She tested some of the math library functions as well.

*Since I had some experience with processing it was easy for me to get into it. The commands are simple and easy to understand. I would like to see more circuit examples and of course typical circuits for various sensors and actuators. The experiments can be done very fast: in my example the only little problem encountered was the scale transformation, but with the minimal knowledge of mathematics such problems can be easily solved.*

*I had used BasicX and Basic Stamps, especially on short projects or workshops. I also used Teleo Makingthings which is easy, but limiting, the thing that I don't like of it is that it has no brain! You always need to use the computer attached to it. With Wiring I can write a program in a familiar environment, similar to processing and download it into the processor. This gives me more possibilities, also Wiring has more input/outputs available, so I can scale my project with no need to add more modules. I cannot wait to have it outside! (Franinovic 2004)*

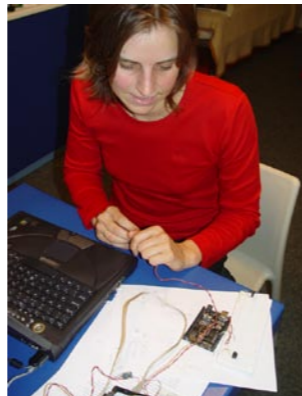

67 Karmen Franinovic doing experiments with Wiring



68 Myriel Milicevic and Maya Lotan doing experiments with Wiring

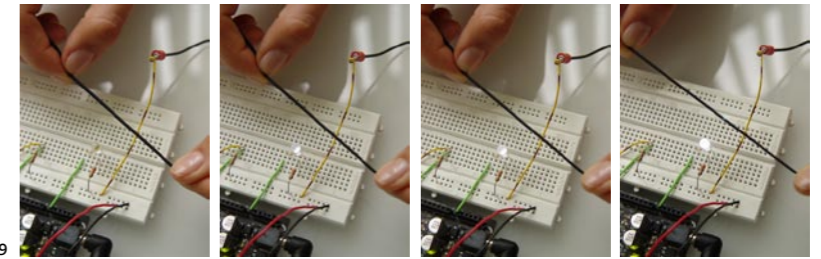

69 Controlling a light's intensity with a stretch sensor  
Karmen Franinovic, 2004

```
// Stretch light
// by Karmen Franinovic <http://people.interaction-ivrea.it/k.franinovic>

// Created 15 May 2004

int val;

void setup()
{
  // nothing for setup
}

void loop()
{
  val = analogRead(0);          // read analog input pin 0
  val = (val - 400) * 0.637;    // scale value
  val = constrain(val, 0, 255); // constrain value
  analogWrite(0,val);          // write value to analaog output 0
  delay(50);                   // wait 50ms for next reading
}
```

#### 4.5. Reactive tables (Powered by Wiring)

A set of “reactive tables” that respond to physical actions from the users. These abstract pieces are the first explorations powered by Wiring. In each piece, the interaction is mediated through the same physical object, the light cube, and the response is created on the table surface, a combination of form and interaction. Each light cube is identical except for the interaction principle it embodies. One interaction principle per table: press and release, inclination and rotation of the light cube. The tables respond accordingly by changing the graphic patterns on their surface.



70

Reactive Tables  
Photograph by Ivan Gasparini

Each table is controlled by a Wiring I/O board. Inside each table there is also a PC computer. Each light cube (one per table) has a different sensor on it. The sensor in the cube is connected to the Wiring board through the cable that connects the cube with the table. This cable also powers the light cube.

The Wiring system, checks for the sensor data and sends the appropriate data to the PC computer through a USB cable. In the PC computer a Processing graphics application is running, and continuously receives data from the Wiring I/O board.



71

Reactive Tables  
Photograph by Ivan Gasparini

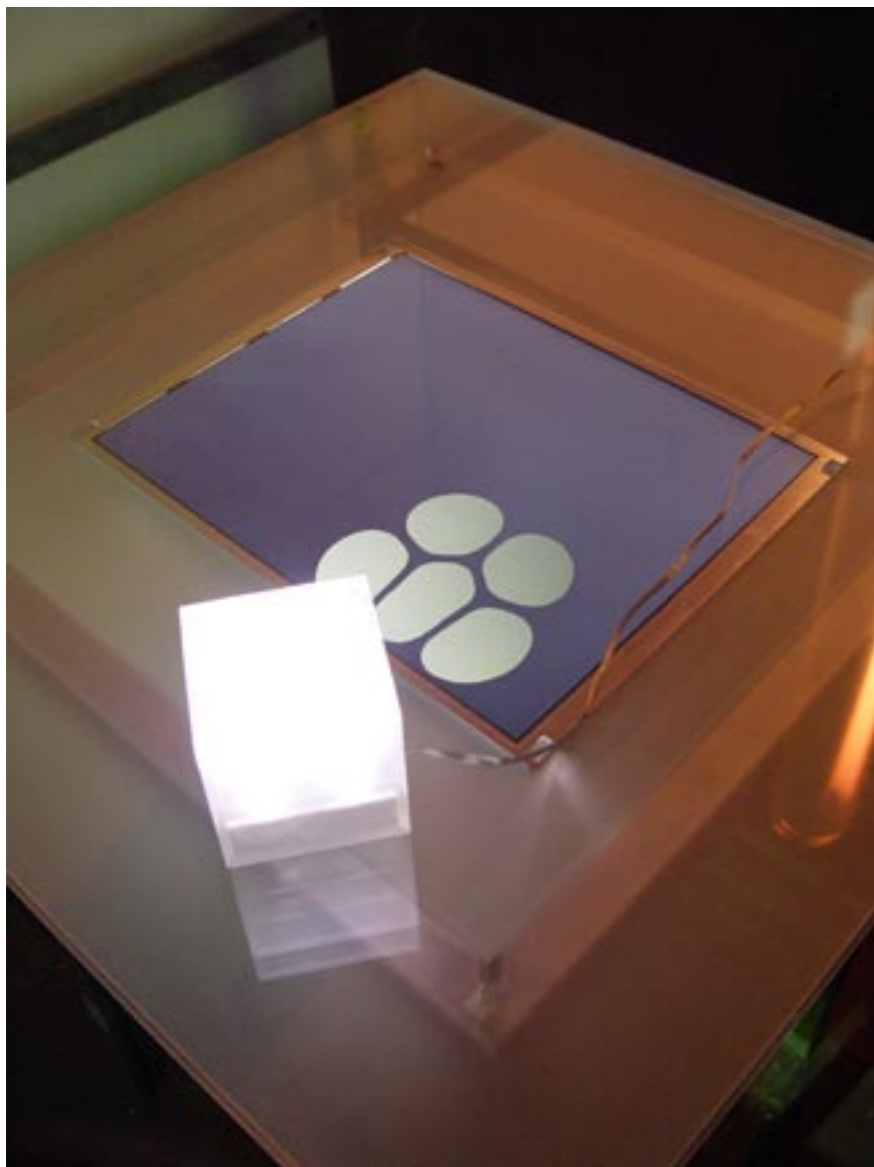

Reactive Tables

72



73

Reactive Tables

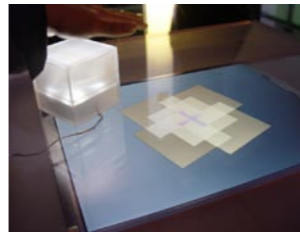

74

Reactive Tables

The data is interpreted making the graphics system to react according to the external manipulation of the light cubes and reflected on the tables' surface.

Exhibited at Milan Triennale, This is Today. L'invasione degli ultracorpi interattivi. April 15-19 2004

#### 4.6. Prototyping aids

Software programs and libraries to support the interconnection of different technologies are very easy to identify while prototyping interaction design projects. A considerable amount of work in this direction has been done at different schools, making available to students software libraries and applications that allow them to interface diverse technologies in the daily prototyping of interactive devices.

One that was very common at IDII was the need to transfer information from/to a physical device to/from a computer, sometimes not only to transfer to/from one but to many computers in a network.

To fulfill this need I designed an application that allows students to send and receive data from or to any kind of microcontroller (including the Wiring I/O board) that is connected to a computer's serial port, to software applications like Macromedia Flash to other computers in the network. What this software does is to open the serial port to communicate with the microcontroller and creates a network server that transmits this data to any network client that connects to this server. Macromedia Flash doesn't have access to the computer's serial port, but has access to the network, so in this case users can connect Flash using its Actionscript language to my interface server, and send and receive data from the microcontroller. This allows for quick prototyping in certain projects, by combining the Flash multimedia capabilities with the realm of hardware.

Data can also be received by other software applications or programs developed in Java, C, or any other language with network connection capabilities.

At the moment this software is being used by students at IDII in a wide variety of prototypes, at the ITP program at NYU, the Massachusetts College of Art in Boston and Dublin City University in Ireland.

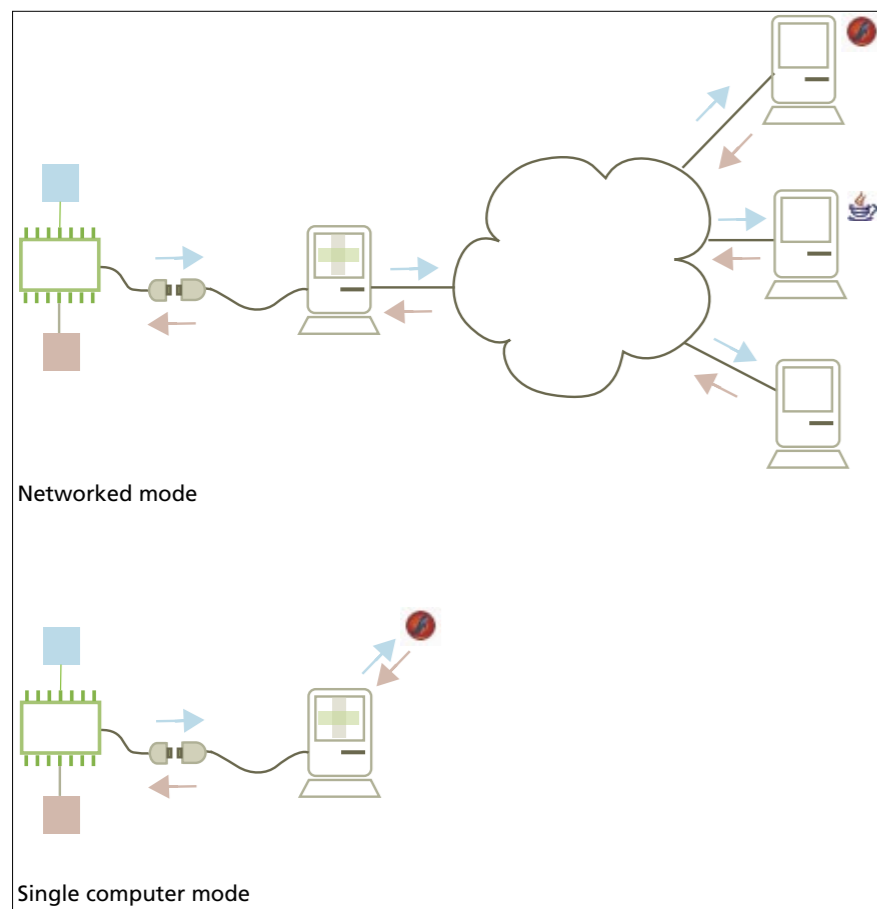

Prototyping modes in which the server is appropriate

75

Soeren Pors' Fight Suit project was one of the first projects at Interaction Design Institute Ivrea that used the server to read data from an accelerometer connected to a microcontroller and send it to a prototype application developed in Macromedia Flash.

*Connecting Flash and the microcontroller was the backbone that enabled the development of the Fight Suit prototype ([www.fightsuit.com](http://www.fightsuit.com)). It took a lot of hard work from Yaniv Steiner to control the accelerometer input, but we ended up with perfect punch response. The Flash connection opened up a new range of prototyping possibilities to normal folks like me. (Soeren Pors, 2004)*



Fightsuit prototype  
Soeren Pors, 2004

76

70

## 4.7 Class support material

Class aid tools are very important in education, not only for communication purposes but also for the class development, and also as reference for future generations of students and the community in general.

In collaboration with my friend Mauricio Giraldo, I developed a courseware system based on previous courseware experiences at Interaction design Institute Ivrea and the MIT Media Lab.

By analyzing features available in Casey Reas' Points & Pixels courseware, DBN courseware at the Massachusetts Institute of Technology (MIT) Media Lab and Reed Kram's courseware for the Controlmania class, we developed a system to support teachers and students in the daily class activities. Taking what we considered the most important features of each of these courseware systems, we combined them into the new one. The courseware system is now part of the Processing project.

Educators can create, edit, modify and consult all the course components (classes, students, problem sets, references, schedule, and syllabus). Students can post, edit and modify solutions to problem sets, document and present their work, and visualize their classmates' solutions to problem sets, thereby facilitating the learning process.

Solutions to problem sets can include Interactive media files like Processing applets, Macromedia SWF format files, Apple QuickTime movies, or popular formats for images on the Web, like PNG, GIF, JPEG etc. The solution can also include text or HTML formatted text, as well as links to other Web sites. The system also provides the web interface for external people to be able to visualize the class activities. Solutions can be visualized by student or by problem set, making it possible to view an individual student's work or the class solution's work for a specific problem.

The graphic layout of the class Web site is completely customizable through CSS and XHTML. The system includes an initial default layout, and English and Spanish language files. More will come as more people use it on their activities.

The first version of this software was available in the summer of 2003 and a new version is currently available for users to download. It requires a one-time instal-

lation per server; detailed instructions are available in the courseware web site. Once the system is installed running, it is possible to create as many courses as needed. It is built on of open source GNU tools and the code was made available to the community. At the moment it is being used at the University of Los Andes in Bogotá, University of California Los Angeles (UCLA), Carnegie Mellon University School of Design, and the Ateneo in Manila. The courseware has also been used to support Processing workshops.

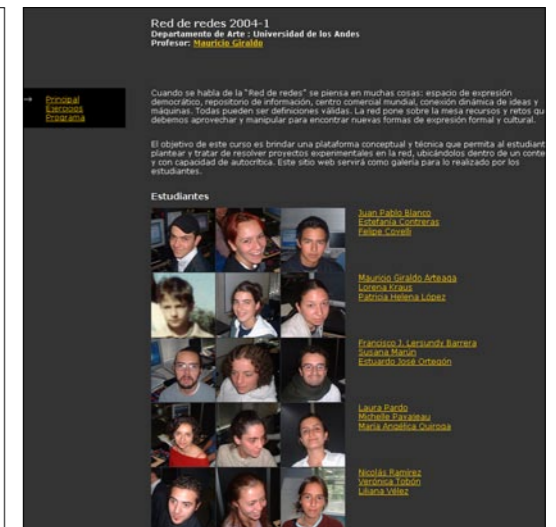
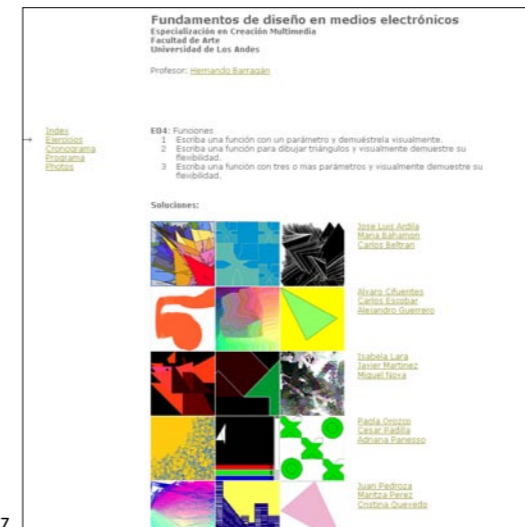
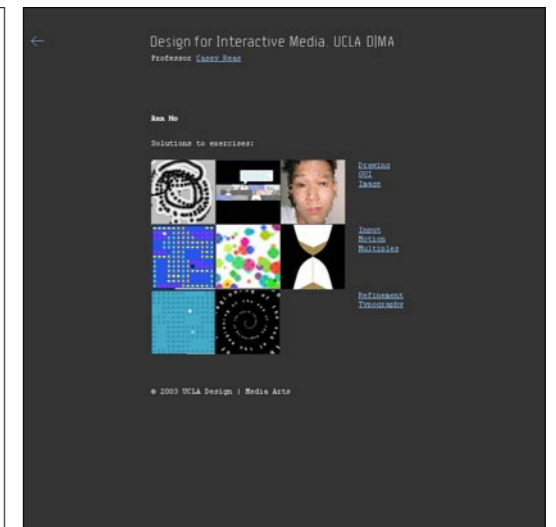
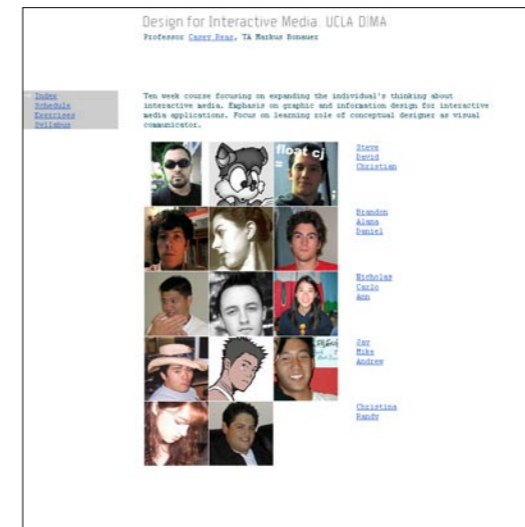
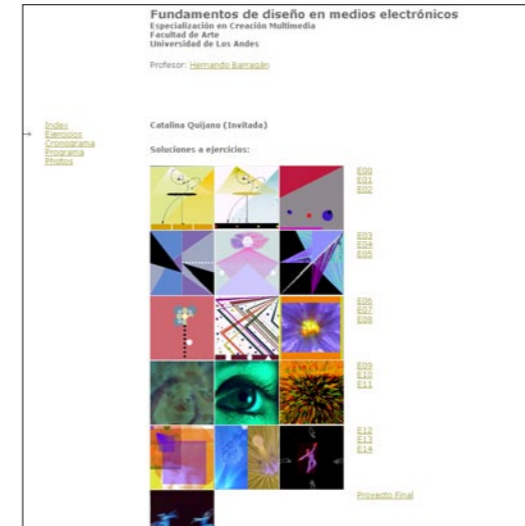
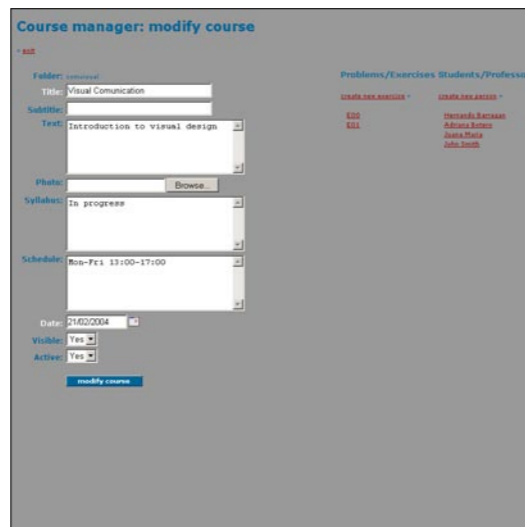
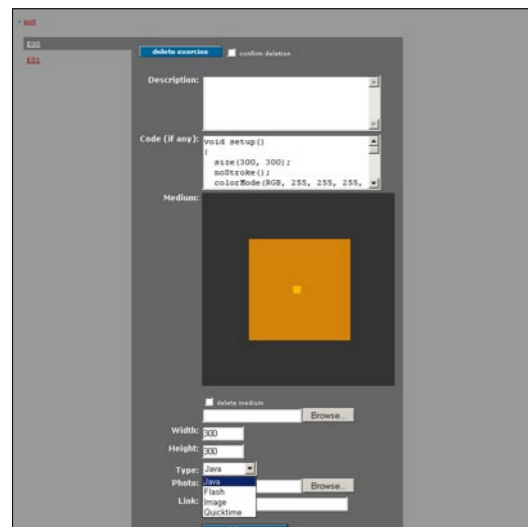
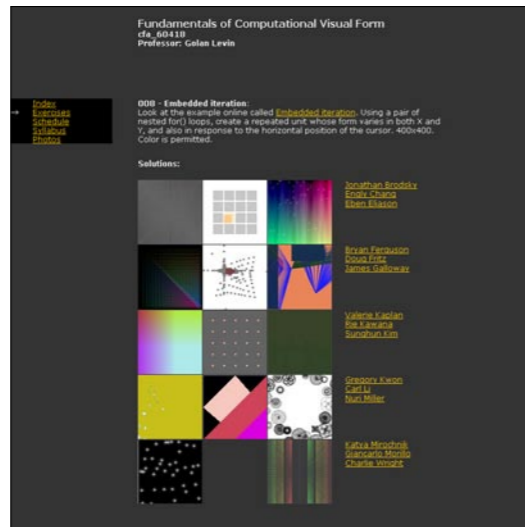
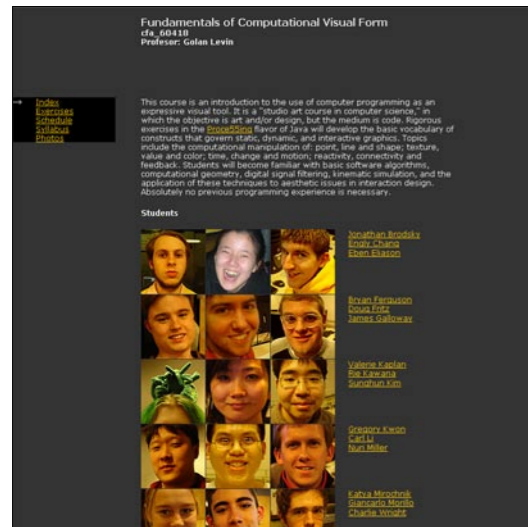

77 Snapshots of the Courseware system in use at different schools

## 5. Conclusions and Future Direction

This project has been an incredible design challenge in on every level. From electronics to visual design, it forced me to execute tasks that required many skills. In this sense it has been an amazing learning experience.

I found obstacles at every turn; some were challenging problems, others more like dead ends that forced me to step back and try a different approach.

For my experience, it was very important to keep open to change and alternatives; it is easy to get caught into something that makes us feel comfortable, specially being in love with technology. In that sense I think my experience as an artist and designer helped me in achieving some balance and getting alternative perspectives of the problems involved in this project.

This project is just starting; a considerable amount of work has to be done to take it further and to the extent I intended. From my thesis work, Wiring is in its initial stage. Now the tools need to be tuned and perfected through the experience and use in school environments and by the community in general.

I am very excited and challenged with the work done, and the expected question: what's next? Everything! I think. It is also exciting to think of the kind of works that hopefully people will do with Wiring.

Processing has opened a path for this project, not only in terms of community, teaching methodologies or technology; however, only the use and experience of Wiring will give me the necessary insights for improvements.

As was the experience with Processing, I expect that my running of workshops will help me gain the necessary teaching experience as I more finely tune the curriculums to achieve the goals of the project.

I devised this project to be used along with Processing to teach in academic environments; doing the initial learning-to-program steps with Processing, then moving into learning basic electronics with Wiring and doing things in parallel. Both will complement each other in taking the user's design experiences into the physical world.

The Wiring programming environment will be subject of constant improvements; that's the nature of software. At the moment an initial version with the basic API is released; but major changes in the software will happen in the following months to reflect the implementation of additional libraries and functionality, as well as to include development environment improvements done for Processing, since Processing and Wiring share the programming environment.

Another important feature that will be added for the next release is the support for some of the lower-end microcontrollers of the Atmel AVR Atmega family, to satisfy the user's needs to deploy higher number of prototypes of its designs in a more cost-effective manner.

Massive amounts of work have to be done in the communication and documentation parts of the project. The Wiring web site will be a constant challenge regarding this matter.

The I/O Board hardware is designed to last for a longer period of time without major changes. The Wiring board is powerful and flexible enough for the actual and future needs of physical interaction design projects in the coming months.

## 6. References

diSessa, Andrea A., Edward H. Lay, [The Berkeley BOXER Project](http://dewey.soe.berkeley.edu/boxer.html/index.html), February 25 2002, <<http://dewey.soe.berkeley.edu/boxer.html/index.html>>

Kay, Alan, [Squeakland](http://www.squeakland.org), May 2004, <<http://www.squeakland.org>>

Logo Computer Systems Inc., [Microworlds](http://www.microworlds.com), May 2004, <<http://www.microworlds.com>>

Maeda, John, Tom White, Ben Fry, Jessica Rosenkrantz, [Design By Numbers](http://dbn.media.mit.edu), Aesthetics + Computation Group. Design By Numbers website. MIT Media Laboratory Aesthetics + Computation Group. Cambridge, August 2 2003, <<http://dbn.media.mit.edu>>

Reas, Casey, Ben Fry, [Processing](http://www.processing.org), MIT Media Laboratory and Interaction Design Institute Ivrea, May 2004, <<http://www.processing.org>>

Martin, Fred, [Fred's World](http://www.cs.uml.edu/~fredm/), University of Massachusetts LOWEL, Jan 27 2004, <<http://www.cs.uml.edu/~fredm/>>

Massachusetts Institute of Technology, [6.270 MIT's Autonomous Robot Design Competition](http://www.mit.edu:8001/courses/6.270/home.html), 2004, <<http://www.mit.edu:8001/courses/6.270/home.html>>

Martin, Fred. [The Handy Board](http://www.handyboard.com), handyboard.com, Aug 27 2003, <<http://www.handyboard.com>>

MIT Media Laboratory Future of Learning Group, [GoGo Board](http://learning.media.mit.edu/projects/gogo), MIT Media Laboratory, April 5 2004, <<http://learning.media.mit.edu/projects/gogo>>

Galbraith, Megan, Simon Greenwold, Justin Manor, [nylon](http://acg.media.mit.edu/projects/nylon), MIT Media Laboratory, Aesthetics + Computation Group, 2002, <<http://acg.media.mit.edu/projects/nylon>>

Galbraith, Megan, [megan galbraith master's thesis, Embedded Systems for Computational Garment Design](http://acg.media.mit.edu/people/megan/thesis.html), 2003, <<http://acg.media.mit.edu/people/megan/thesis.html>>

Stang, Pascal, [AVRmini Boards](http://hubbard.engr.scu.edu/embedded/avr/avrmini), Santa Clara University, Nov 9 2003, <<http://hubbard.engr.scu.edu/embedded/avr/avrmini>>

Bishop, Durrell, [Durrell Bishop](http://www.durrellbishop.com), <<http://www.durrellbishop.com>>

Verplank, Bill, [Bill Verplank](http://www.billverplank.com), <<http://www.billverplank.com>>

Banzi, Massimo, [potemkin.org](http://www.potemkin.org), <<http://www.potemkin.org>>

Reas, Casey, [GroupC.net / REAS](http://www.groupc.net), April 2004, <<http://www.groupc.net>>

UCLA Design | Media Arts, [UCLA Design | Media Arts / SenseLab](http://dma.ucla.edu/senselab), April 2004, <<http://dma.ucla.edu/senselab>>

O'Sullivan, Dan, [Dan O'Sullivan](http://fargo.itp.tsoa.nyu.edu/~dano), ITP NYU, May 2004, <<http://fargo.itp.tsoa.nyu.edu/~dano>>

Igoe, Tom, [Tom Igoe](http://stage.itp.nyu.edu/~tigoe), ITP NYU, May 2004, <<http://stage.itp.nyu.edu/~tigoe>>

Berzowska, Joanna, [Joanna Berzowska](http://hybrid.concordia.ca/~joey), Concordia University, May 2004, <<http://hybrid.concordia.ca/~joey>>

Nimoy, Josh, [The Work of Josh Nimoy](http://www.jtnimoy.com), ITP NYU, March 2004, <<http://www.jtnimoy.com>>

Stang, Pascal, [SCU Robotics Systems Laboratories](http://hubbard.engr.scu.edu/embedded), Santa Clara University, April 1 2003, <<http://hubbard.engr.scu.edu/embedded>>

Lawson, Cynthia, [Physical Computing](http://stage.itp.tsoa.nyu.edu/~cl457/pcomp), ITP NYU, 2003, <<http://stage.itp.tsoa.nyu.edu/~cl457/pcomp>>

Co, Elise, [elise co](http://acg.media.mit.edu/people/elise), Aesthetics + Computation Group. MIT Media Laboratory, August 8 2001, <<http://acg.media.mit.edu/people/elise>>

Koser, Mikkell, [Drawing Machine Project](http://proce55ing.beyondthree.com/tutorial/drawingmachine), Interaction Design, Royal College of Art, May 2003, <<http://proce55ing.beyondthree.com/tutorial/drawingmachine>>

Van Ooijen, Wouter, Eur van Andel, Mark Gross, Javier Martinez, Craig Franklin, [Jal - Just Another Language](http://jal.sourceforge.net), June 4 2003, <<http://jal.sourceforge.net>>

Parallax Inc. Stamps in Class, Parallax Bbasic Stamp, <[http://www.parallax.com/html\\_pages/edu/index.asp](http://www.parallax.com/html_pages/edu/index.asp)>

Netmedia Inc. BasicX by NetMedia Inc., <<http://www.basicx.com>>

Microchip, Microchip Technology. Inc Home Page, May 2004, <<http://www.microchip.com>>

Atmel Corporation, Atmel AVR 8-Bit RISC Homepage, May 2004, <<http://www.atmel.com/products/AVR>>

Atmel Corporation, AT91 Arm-based Microcontrollers Homepage, May 2004, <<http://www.atmel.com/products/AT91/>>

Systronix Inc, IStamp™, 2003, <<http://www.systronix.com/jstamp>>

Maxim/Dallas Semiconductor Corp., TINI: Introducing TINI, 2004, <<http://www.ibutton.com/TINI/index.html>>

Rabbit Semiconductor, Rabbit Semiconductor | Microprocessors and Development tools for Embedded Control and Communications, 2004, <<http://www.rabbitsemiconductor.com>>

Makingthings LLC, PRODUCTS, 2004, <<http://www.makingthings.com/products/products.htm>>

Infusion Systems, Infusion Systems :: I-CubeX, MIDI sensor control for research, education, art, music, dance and more, 2003, <<http://www.infusionsystems.com>>

Pond Electronics, Pond – Embedded Systems Products, 2003, <<http://www.pond.ie/products/index.htm>>

MIT Media Laboratory, aesthetics + computation group. MIT media laboratory, 2004, <<http://acg.media.mit.edu>>

Interactivity Consultants, Physical Interactivity and Interaction Design School Guide, 2003, <[http://www.interactivityconsultants.com/pages/alternate\\_indexes/LowF\\_interactivity\\_curriculum\\_education.htm](http://www.interactivityconsultants.com/pages/alternate_indexes/LowF_interactivity_curriculum_education.htm)>

Zadeh, Lotfi , BISC Program: Soft Computing The Berkeley Initiative on Soft Computing, Berkeley University of California, 2003, <<http://www.cs.berkeley.edu/~zadeh>>

Mann, Steve, Wearable Computing, University of Toronto, 2003, <<http://about.eyetap.org/library/weekly/aa061500a.shtml>>

Verplank, Bill, Physical Interaction Design – Autumn 2002, Interaction Design Institute Ivrea, 2002, <<http://www.interaction-ivrea.it/courses/2002-03/physical-computing>>

Banzi, Massimo, InflatedEgoTeachingPhysicalComputing, Interaction Design Institute Ivrea, 2003, <<http://conncomm.interaction-ivrea.it/zope/inflatedego/TeachingPhysicalComputing>>

Verplank, Bill, Max Mathews, MUSIC 250a / CS377C – HCI Theory and Practice, Human Computer Interaction Design Stanford University, 2004, <<http://ccrma-www.stanford.edu/courses/250a>>

ETH, Swiss Federal Institute of Technology, Wearable Computing Lab : Welcome to the Wearable Computing Lab, ETH, Swiss Federal Institute of Technology Zurich, Jan 4 2004, <<http://www.wearable.ethz.ch>>

Seymour, Sabine, fashionable technology, Parsons School of Design Center for New Design, 2003, <<http://a.parsons.edu/~fashiontech>>

FSF Europe, FSF Europe – Education – Argumentation. Why give precedence to Free Software at school?, Free Software Foundation Europe, February 2 2003, <<http://fsfeurope.org/projects/education/argumentation.en.html>>

Utterback, Camille, Fang-Yu Lin, Major Studio - Physical Computing, Spring 2002, Parsons School of Design, 2002, <<http://a.parsons.edu/~linf/pc/sp02>>

Camarata, Ken, Mark D Gross, Ellen Yi-Luen Do, [dmg . publications . Physical Computing: A Design Studio that Bridges Art, Science, and Engineering], Washington University, March 13 2003, <<http://dmg.caup.washington.edu/xmlSiteEngine/browsers/stylin/publication134.html>>



Winograd Terry, *From Computing Machinery to Interaction Design*, Stanford University Program in Human-Computer Interaction, 1997, <<http://hci.stanford.edu/~winograd/acm97.html>>

edu/~winograd/acm97.html>

McCullough, Malcolm, *Abstracting Craft: The Practiced Digital Hand*, MIT Press, 1998.

Pors, Soeren, *Fightsuit*, 2004, <<http://www.fightsuit.com>>

Myers, B., *Creating Interaction Techniques by Demonstration*, appears in *Visual Programming Environments: Paradigms and Systems*, Ed. Ephraim P. Glinert, 1990.

Norman, D. A., *Things that make us smart*, Addison-Wesley, Reading, MA, 1993.

Maeda, John. *Design By Numbers*, MIT Press, Cambridge, MA. 1999.

Jones, Joseph L., Flynn Anita M., Seiger Bruce A., *Mobile Robots*, Ed. A K Peters, Ltd. 1999.

Kernighan B. W., D. M. Ritchie, *The C Programming Language*, Prentice-Hall: Englewood Cliffs, NJ, 1978. Second edition, 1988

D. Svanaes, *Understanding Interactivity. Steps to a Phenomenology of Human-Computer Interaction*, Phd Thesis, Trondheim, 1999.

Atmel Corporation, *8-Bit AVR Microcontroller with 128K Bytes In-System programmable Flash ATmega128 ATmega128L Preliminary*, 2003.

Atmel Corporation, AVR061: "STK500 Communication Protocol", *Application Note*, 2003.

Atmel Corporation, *AT91 ARM@ Thumb@ Microcontrollers, AT91R40008*, Summary, 2003.

Atmel Corporation, *AT91 ARM@ Thumb@ Microcontrollers, AT91R40008*, Electrical Characteristics, 2003

## Apendix A. Wiring I/O Board Circuit Schematics

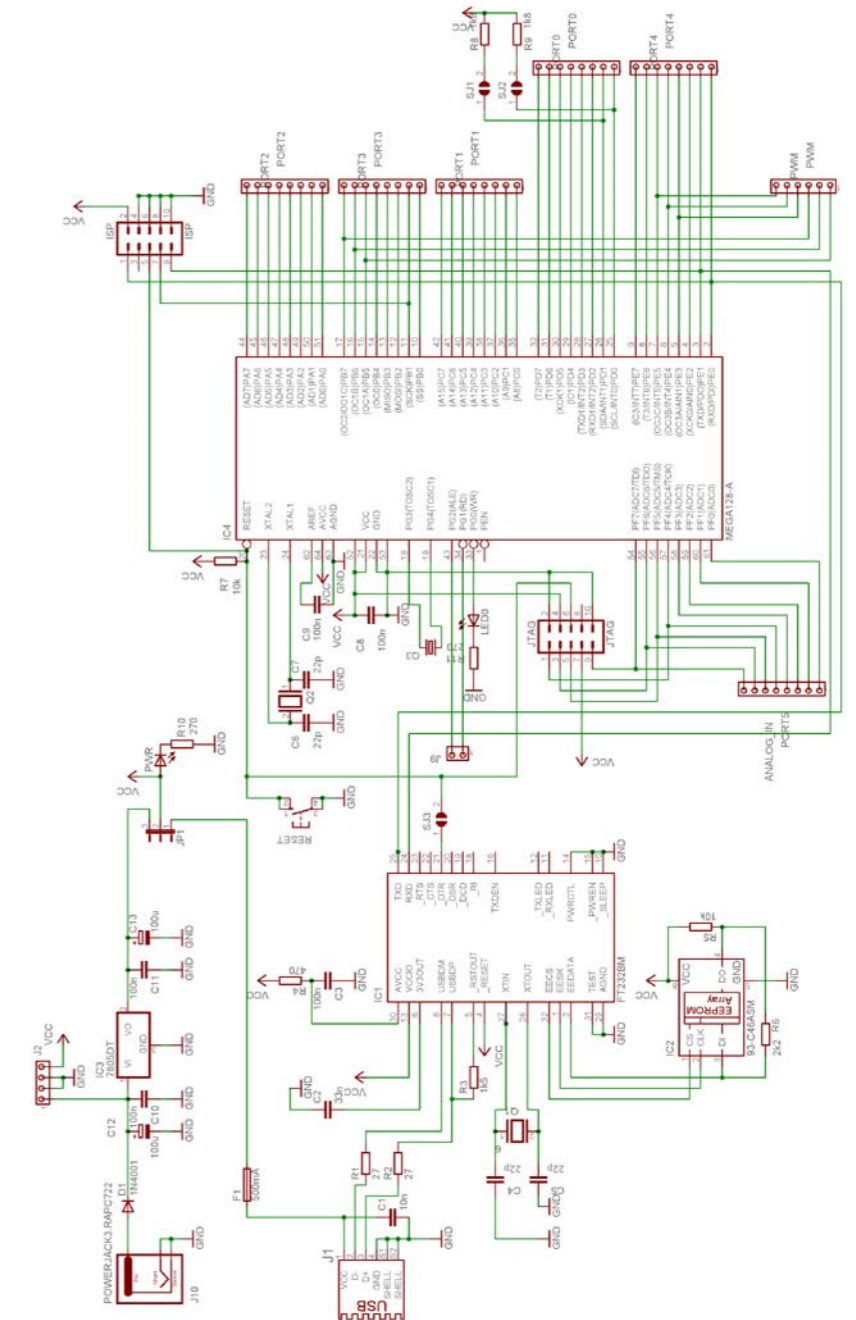

## Appendix B. Wiring I/O Board Layout

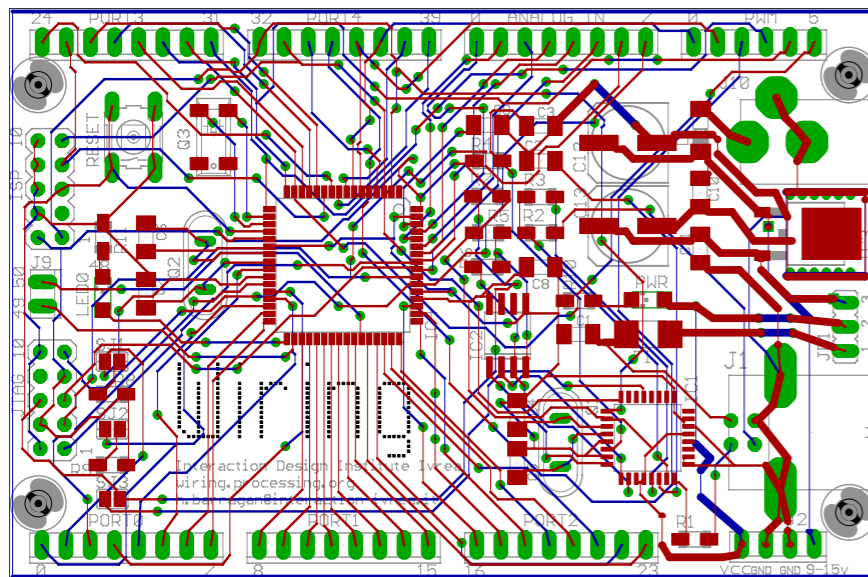

### Colophon

This document was prepared with Adobe InDesign.

The text of this thesis was set on 14 points of lead in eight point Caecilia (1991), designed by Peter Matthias Noordzij and issued by Linotype in 1991.

The Wiring I/O board circuit was designed and laid out using Cadsoft Eagle Free-ware Light Edition. <<http://www.cadsoft.de>>

